

Wine Rack Instruction Manual

Step 1

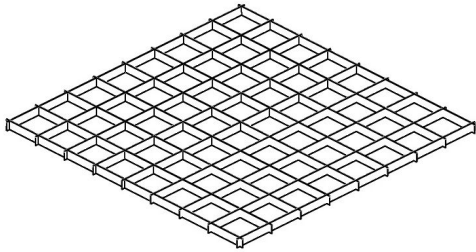

Assemble the bottom metal frame on a flat surface.

Step 2

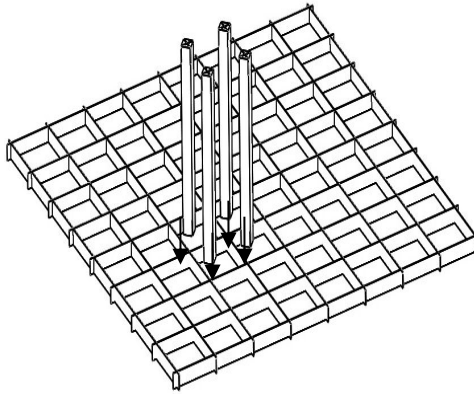

Line up and insert the wood rack pieces into the metal frame. Use a rubber mallet to install into the metal cross frame. Repeat until all wood rack pieces are installed.

Step 3

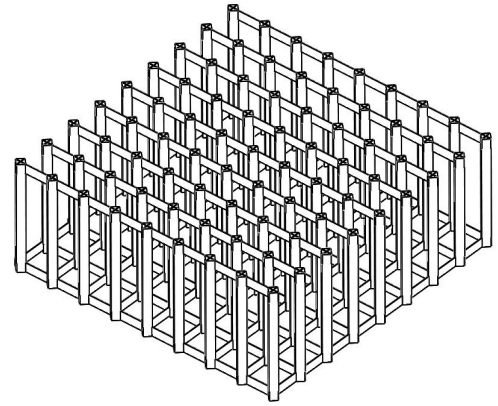

Very important! Insert one section of the metal frame only half way down into the wood pieces.

Step 4

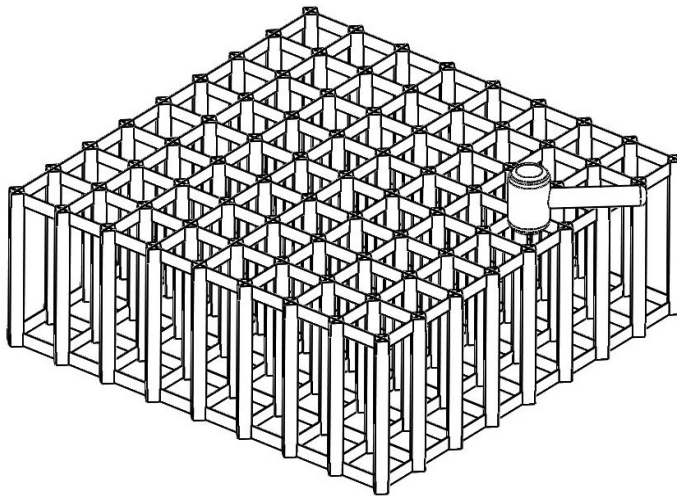
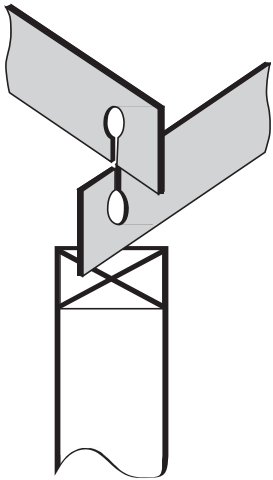

Insert the second section of the metal frame into the first and using a rubber mallet complete the installation into the wood pieces.

Step 5

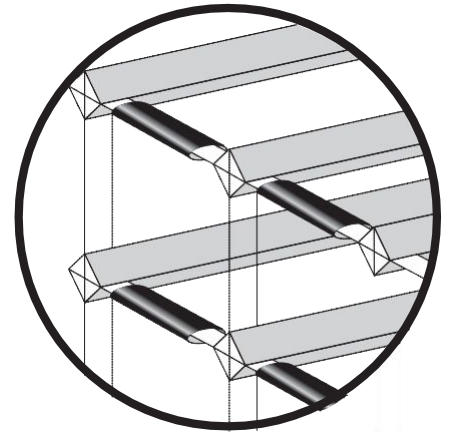

The bottle neck label protectors snap onto the front side of the metal frame as shown.

A X72



B X81



235*27.5*27.5MM

C X36



24*782.5*1.0MM

Parts Included:

- A Protectors x72 pcs
- B Wood slats x81 pcs
- C Metal pieces x36 pcs