

MODEL:WB-F-HOUSE-ROCK-S
VERSION:1.0
SINGLE HOUSE BED

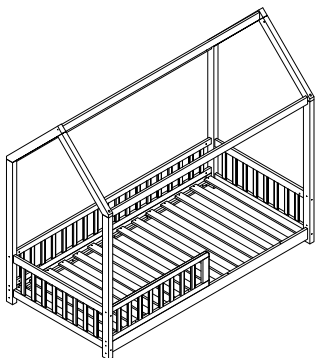

OPTION A

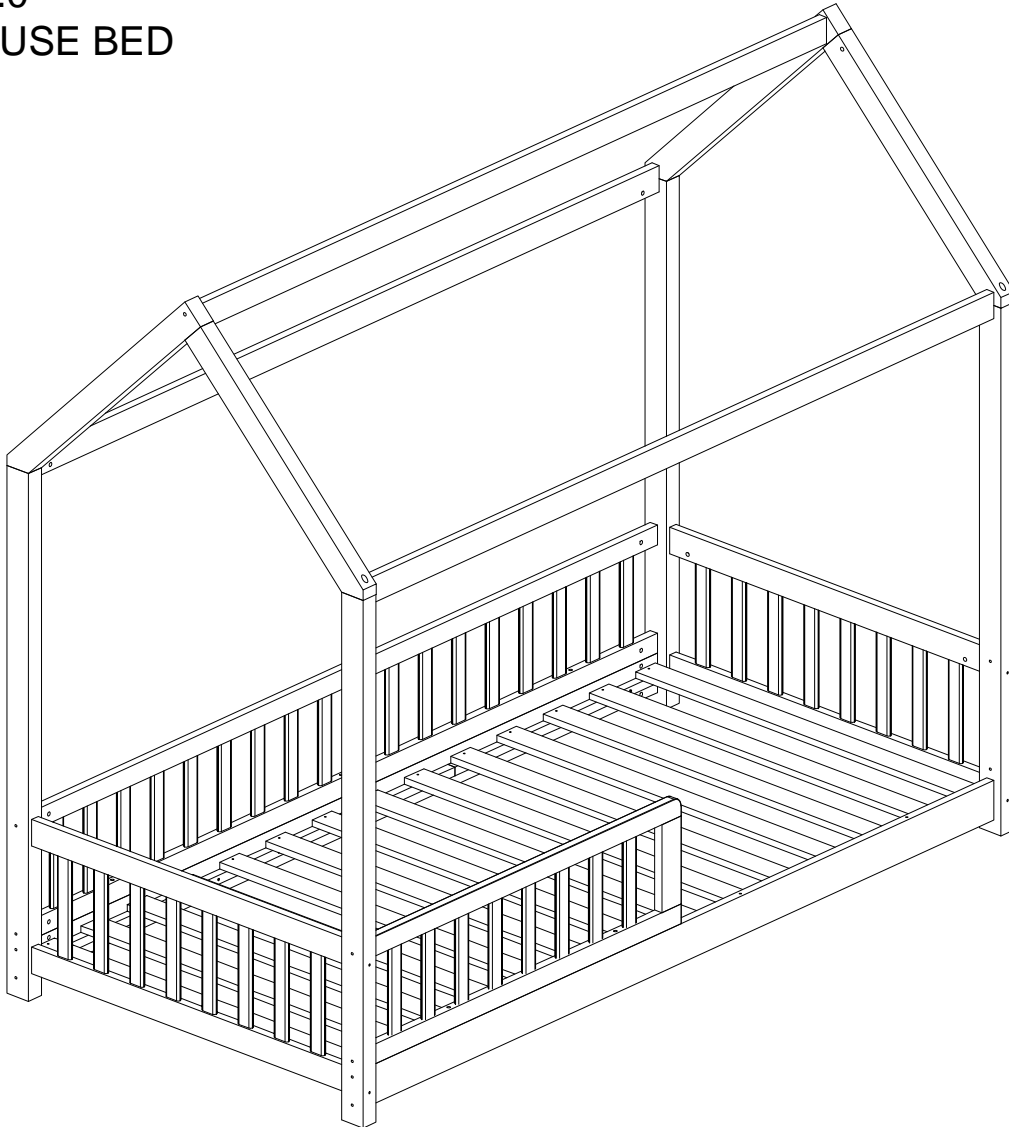
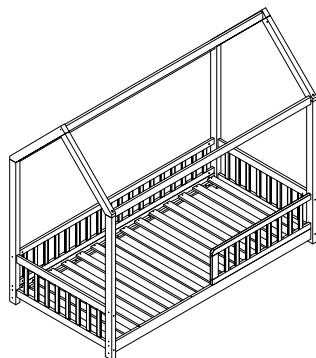

OPTION B

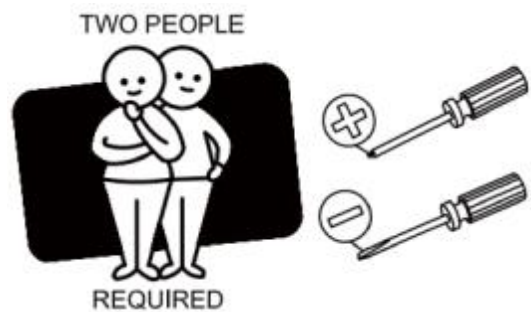

Assembly checklist



Read through the instructions carefully before you begin.



Make sure you have all the required tools. Do not use power tools.



Identify and lay out all of the components before you begin assembly.

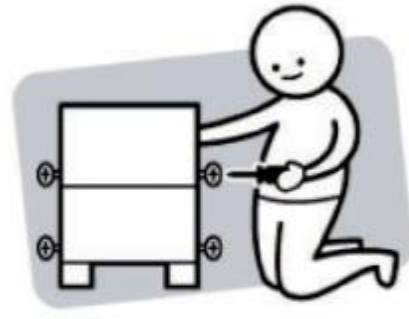







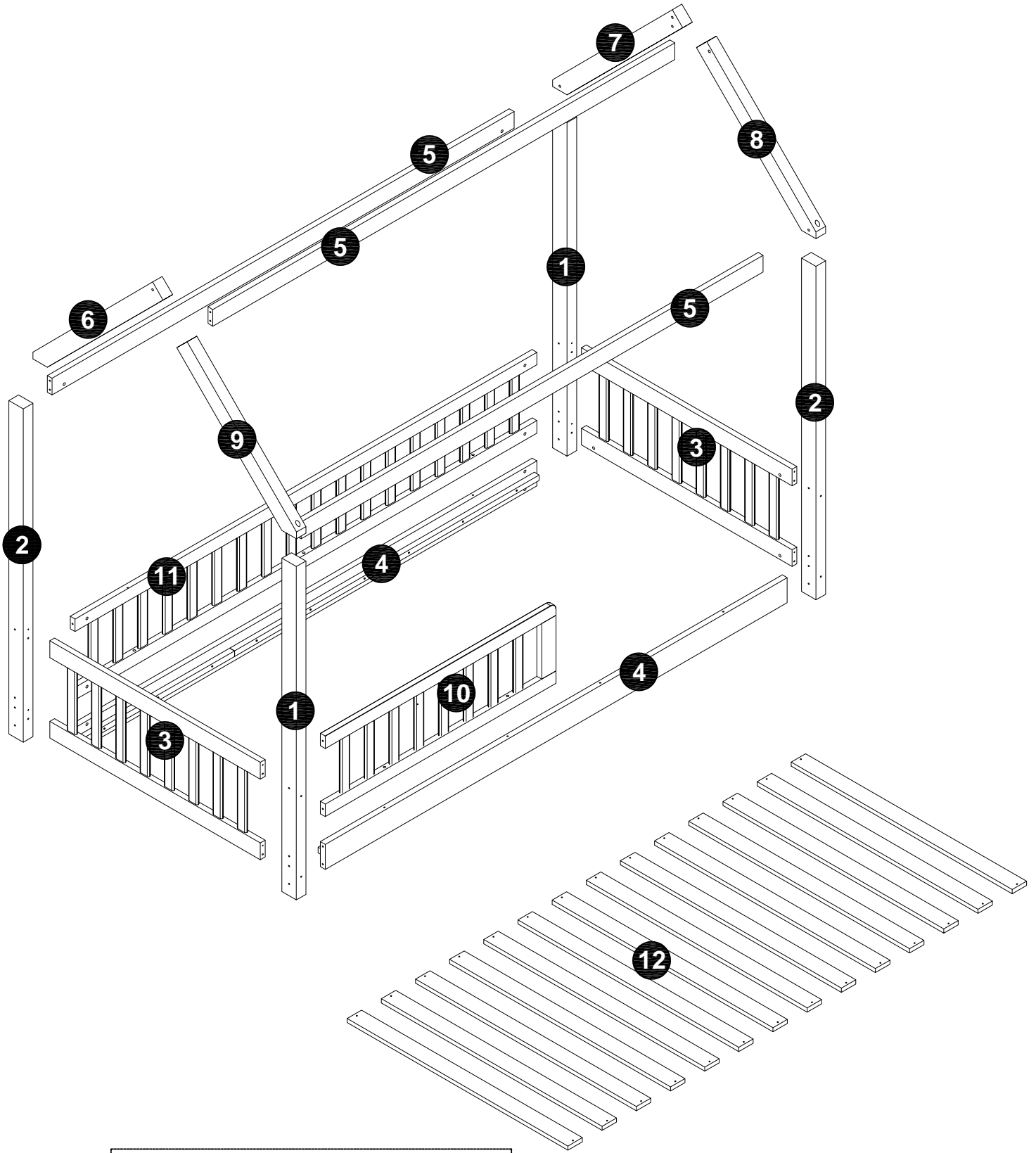

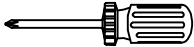
Do not fully tighten all screws until step/ process finished.

Useful Information



- ! Never use power tools, they can damage your components or hardware if used incorrectly.
- ! The most common mistakes made during assembly are using the wrong hardware or getting components back to front.
- ! Always use a soft surface (such as carpet or cardboard) when assembling your product to avoid scratching or damaging the surface of the product.
- ! Never use any glue until you are certain that the parts belong together.

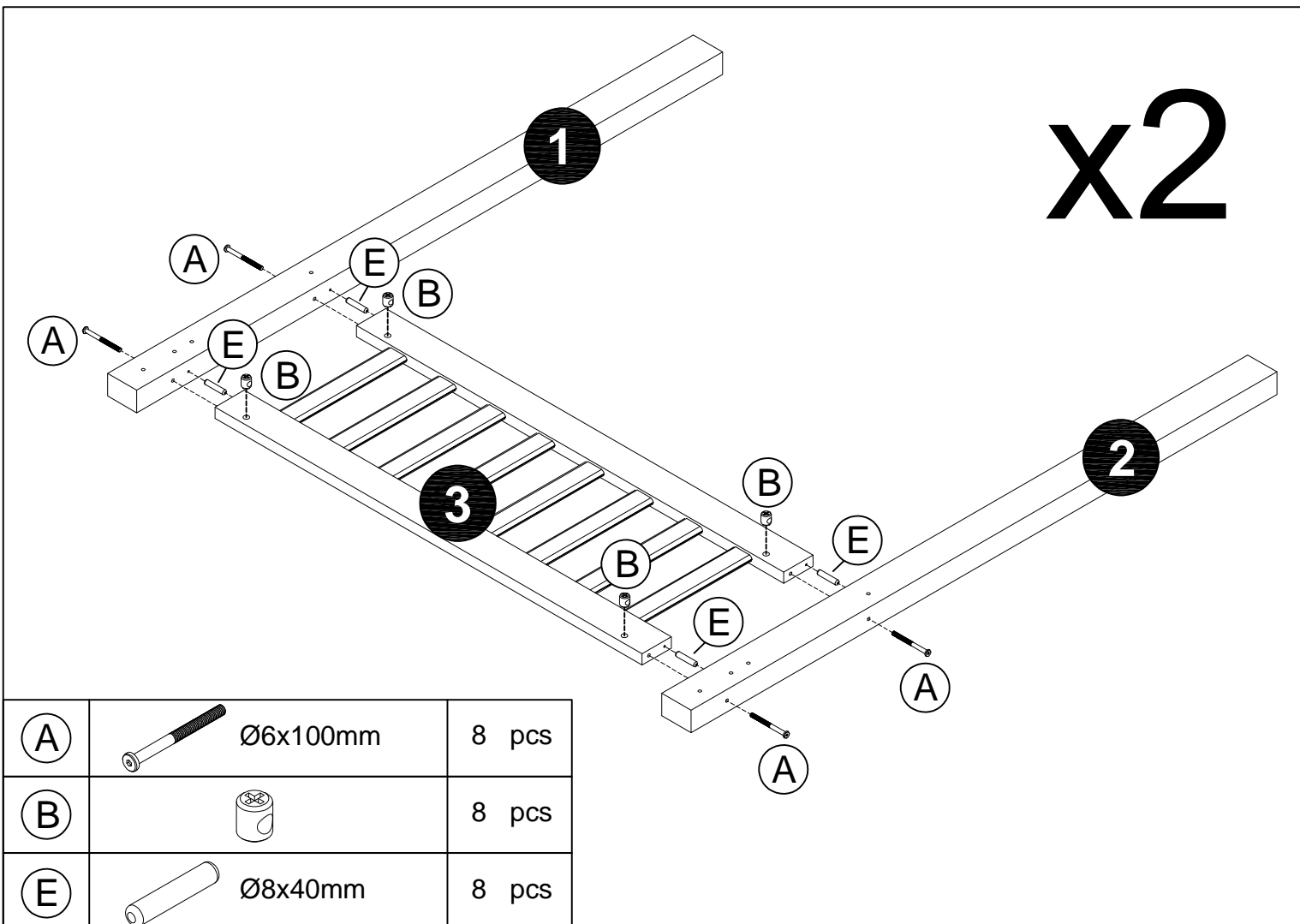

Required Screwdriver					
(A)	 Ø6x100mm	10 pcs	(E)	 Ø8x40mm	20 pcs
(B)		30 pcs	(F)	 Ø4.2x30mm	28 pcs
(C)	 Ø6x80mm	20 pcs	(G)	 M4	1 pc
(D)	 Ø6x60mm	4 pcs	(H)	 Ø6x40mm	5 pcs



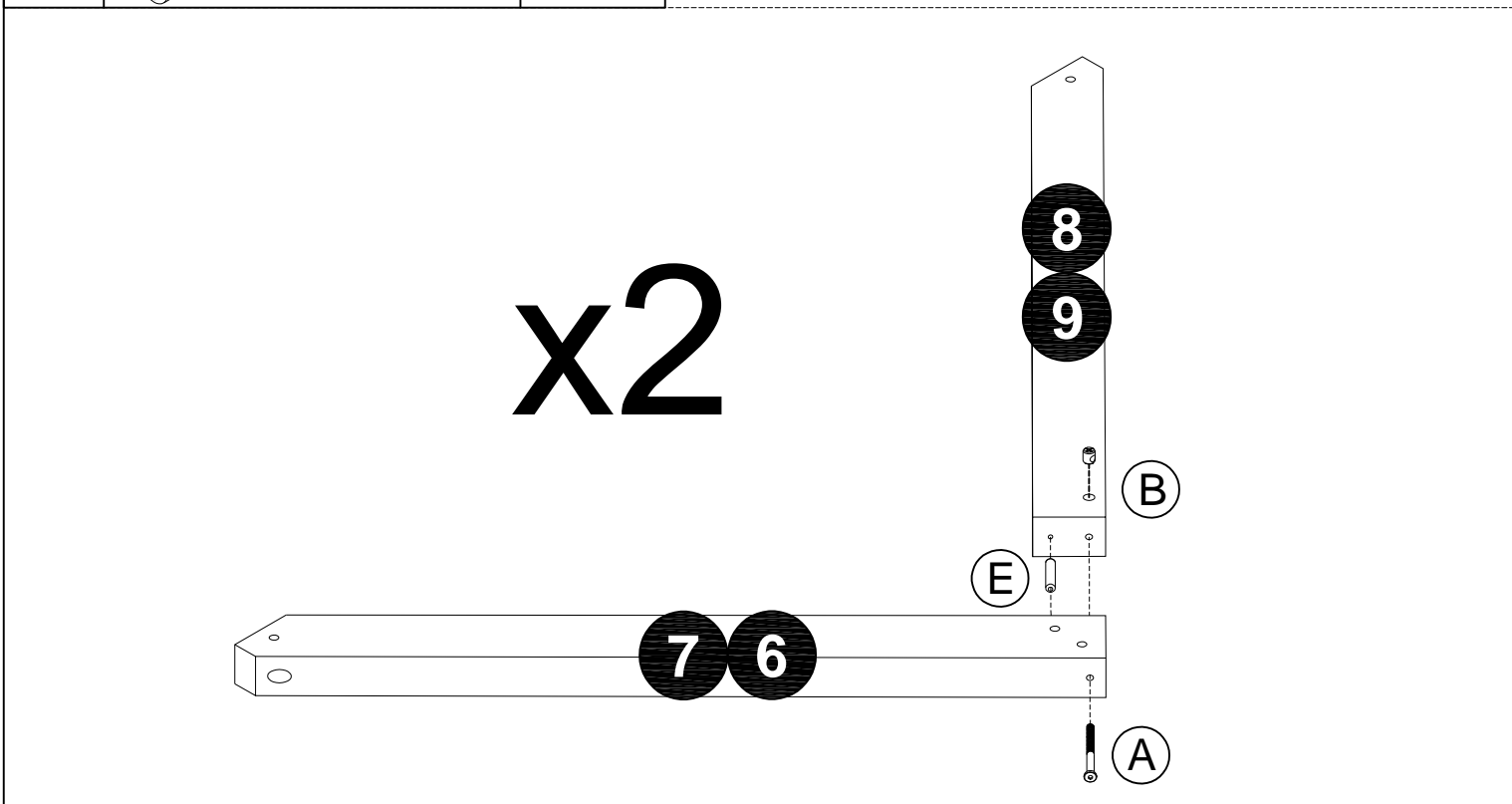

x2

(A)	 Ø6x100mm	8 pcs
(B)		8 pcs
(E)	 Ø8x40mm	8 pcs

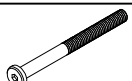

x2

(A)	 Ø6x100mm	2 pcs
(B)		2 pcs
(E)	 Ø8x40mm	2 pcs

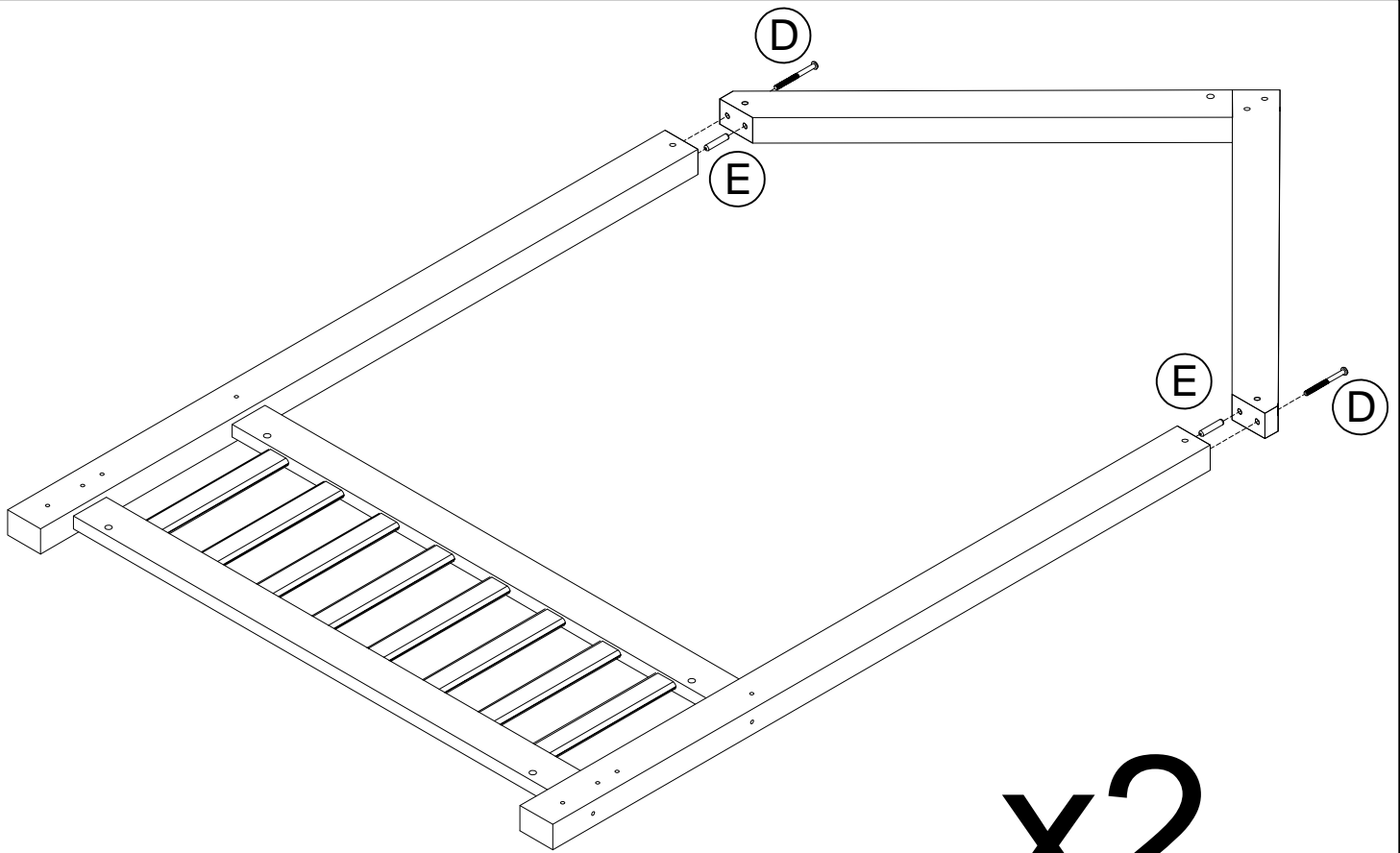



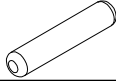

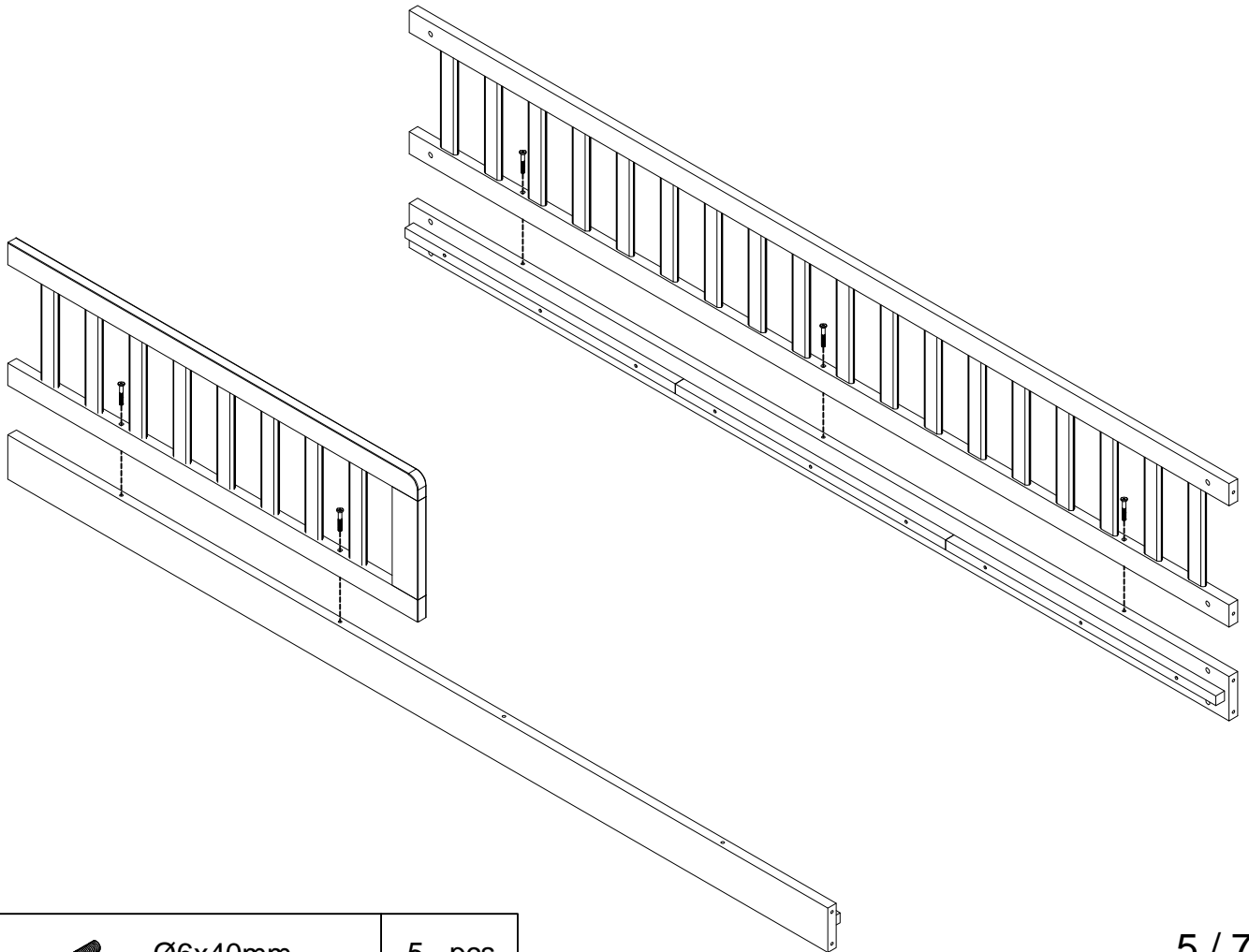
x2

D	 Ø6x60mm	4 pcs
E	 Ø8x40mm	4 pcs

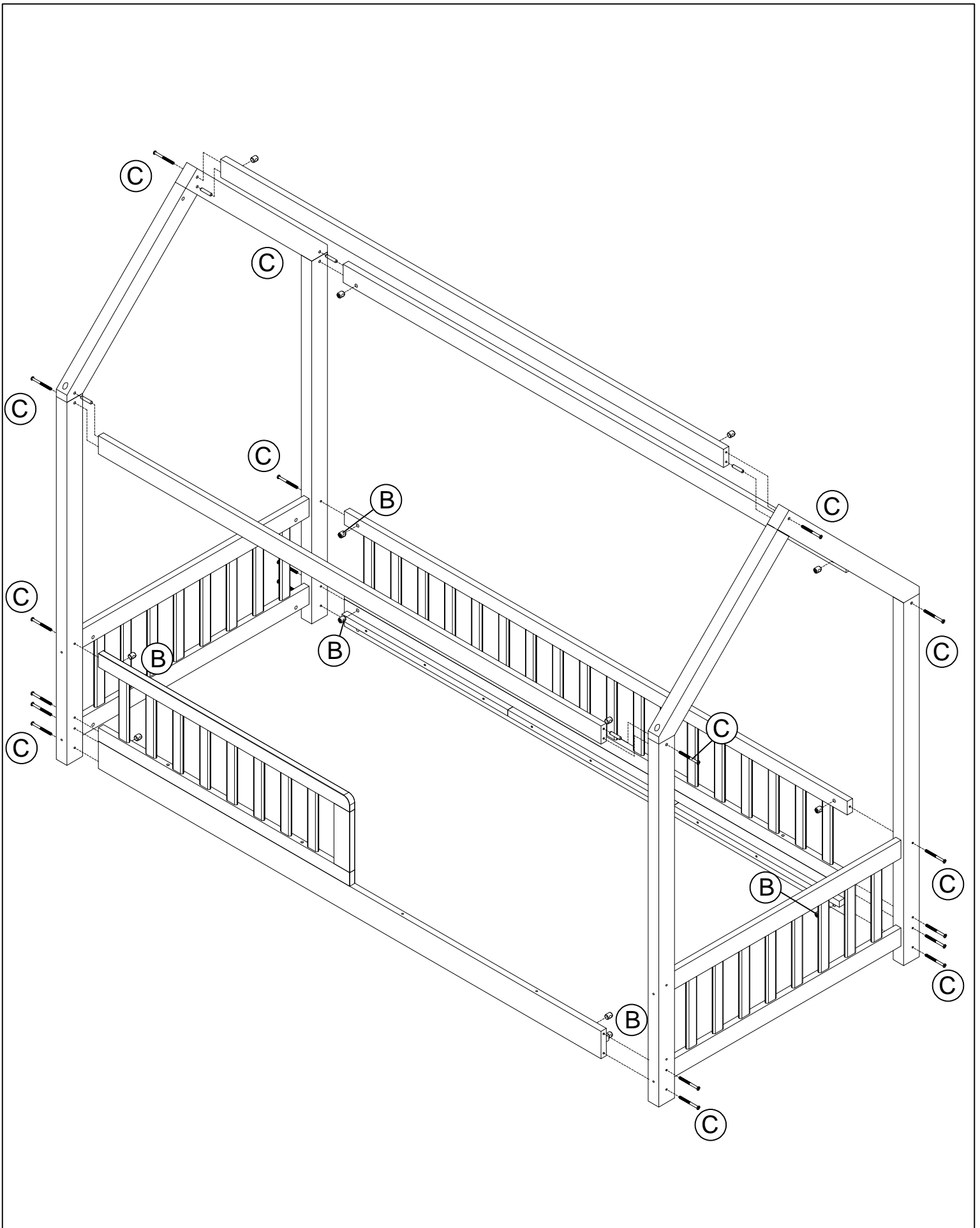

H	 Ø6x40mm	5 pcs
---	---	-------



(B)		20 pcs
(C)	 Ø6x80mm	20 pcs
(E)	 Ø8x40mm	6 pcs

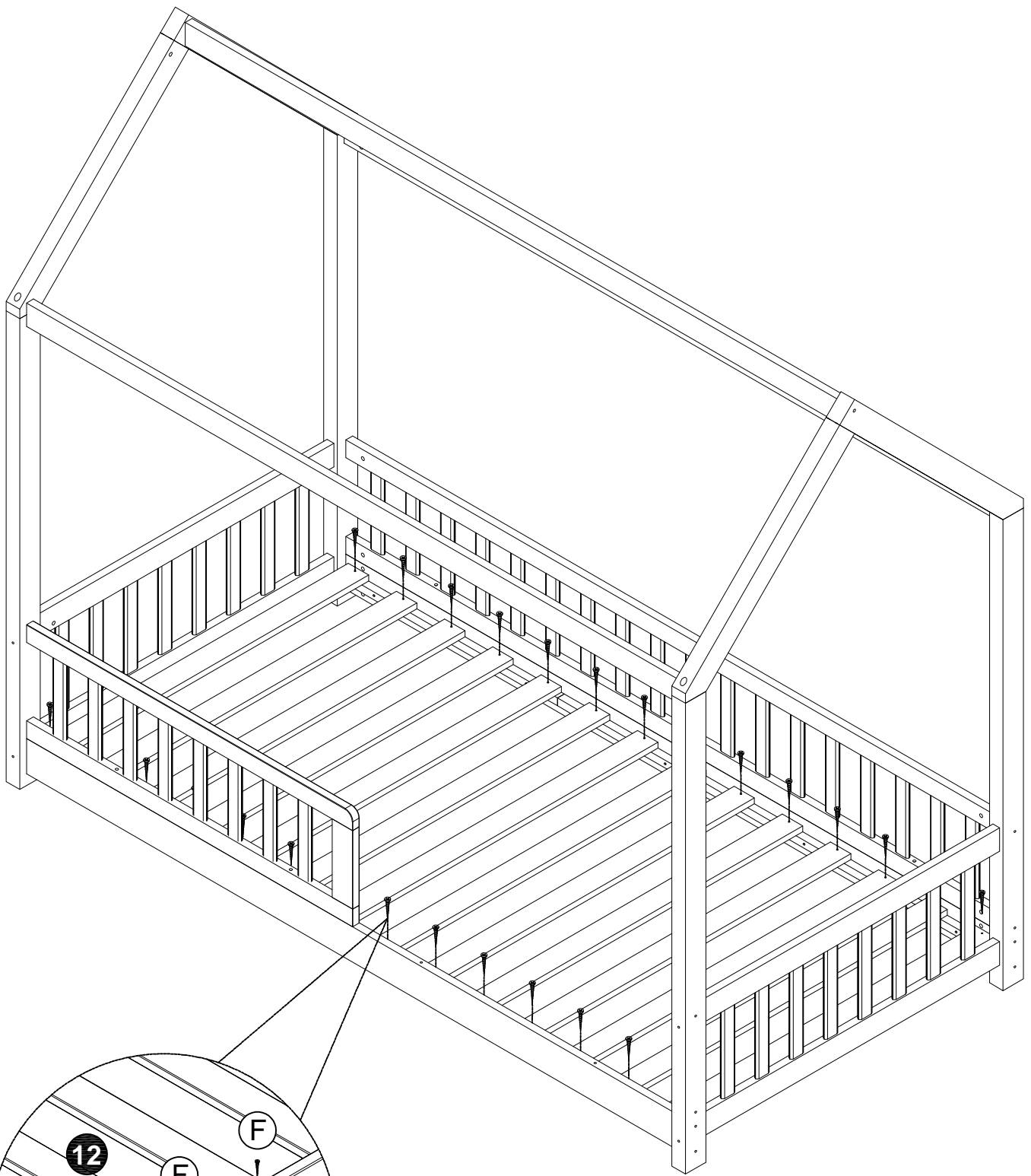

ⓕ	 Ø4.2x30mm	28 pcs
---	---	--------