

WARNING

1. Tighten screws firmly but do not over tighten. Over tightening can damage the screws and greatly reduce their holding strength.
2. Ensure mounting screws are anchored in the centre of the studs. Use of an 'edge to edge' stud finder is highly recommended.

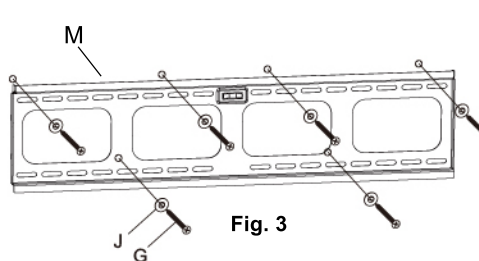
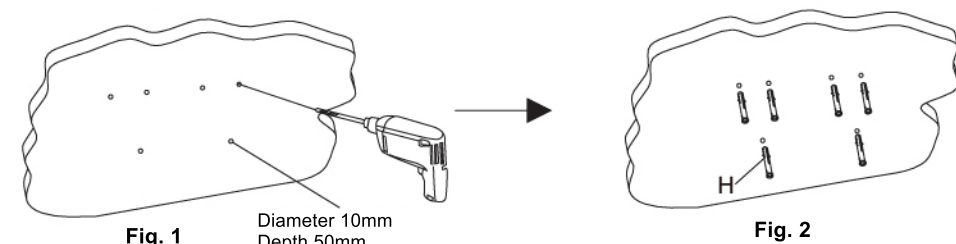

STEP 1
Drill into the wall and place six 10x50 concrete anchors (H) into the holes as shown in Fig. 1 and 2. Next, attach the wall board (M) to the wall using six lag bolts (G) and spacers (J) as shown in the Fig. 3. Use a spirit level to ensure the wall board (M) installation is levelled.

STEP 2
Place the A-F bolt into the spacer (I) and then attach the spacer (I) to the TV holder (L). Next, align the TV holder (L) with the TV set mounting holes and place washers (K) in between them as shown in Fig. 4. Tighten the A-F bolts to secure the TV holder (L) to the TV set.

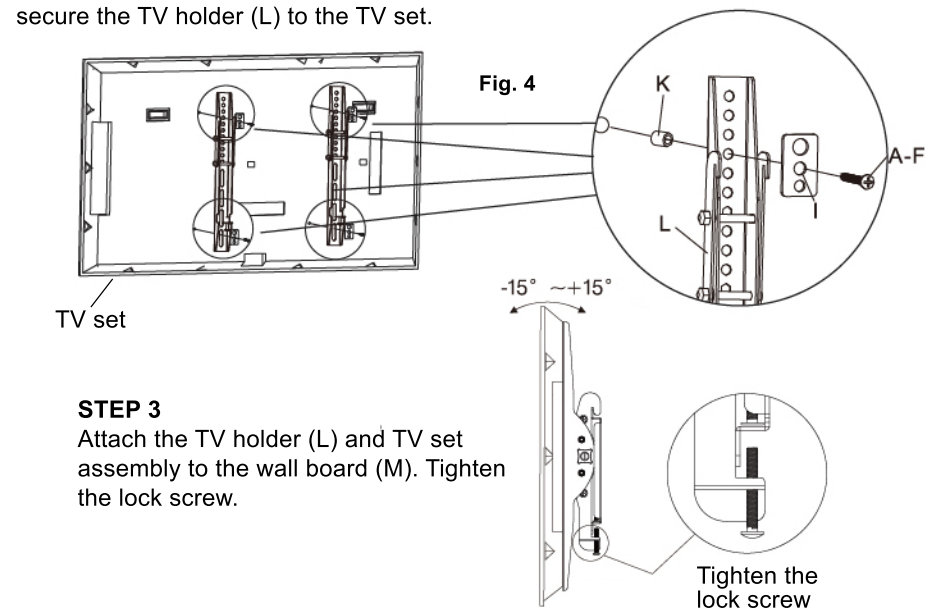

STEP 3
Attach the TV holder (L) and TV set assembly to the wall board (M). Tighten the lock screw.

Tighten the lock screw



INSTALLATION INSTRUCTIONS

MODEL: TV-MOUN-B-WALL-200BT

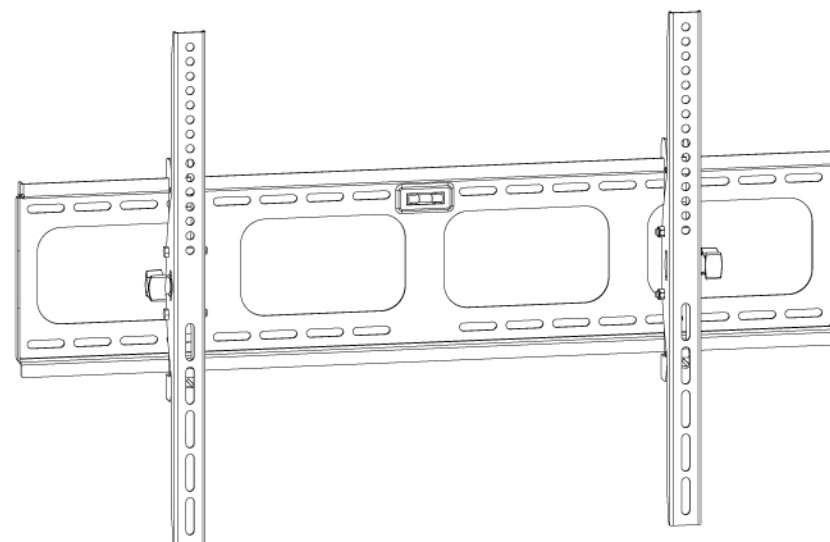

42"-90"



800mmx400mm

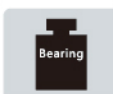

50kg

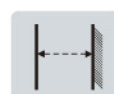

65mm

! WARNING

1. Please read these instructions carefully before installing this product to avoid product damage and personal injury.
2. Please refer to the manufacturer's installation recommendations for the required distance away from wall to avoid the risk of property damage.
3. This product should only be installed by a person of good mechanical aptitude with basic building experience and can fully understand the instructions.
4. Ensure that the supporting surface will be able to safely support the combined load of the product and all other attached equipment and components.
5. Never exceed the maximum load capacity of the product.
6. If mounting to wall studs, ensure that the mounting screws are anchored in the centre of the studs. Use of an 'edge to edge' stud finder is highly recommended.
7. This product is intended for indoor use only. Use of this product outdoors could lead to product failure and personal injury.

PARTS LIST

PART	QTY	INDEX
Bolt M5x16	4	A
Bolt M5x30	4	B
Bolt M6x16	4	C
Bolt M6x30	4	D
Bolt M8x16	4	E
Bolt M8x30	4	F
Lag bolt St8x50	6	G
Concrete anchor 10x50	6	H
Spacer with 3 holes	4	I
Ø8.5x18x1.5 Spacer	6	J
Ø8.5x18x15 Washer	4	K
TV holder	2	L
Wall board	1	M

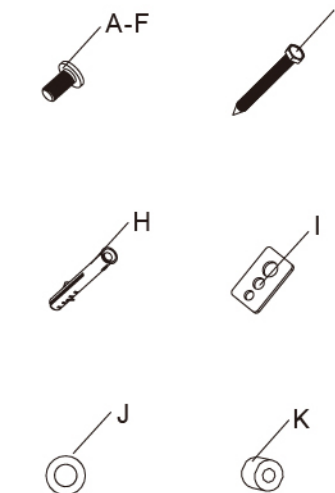

INSTALLATION STEPS

