

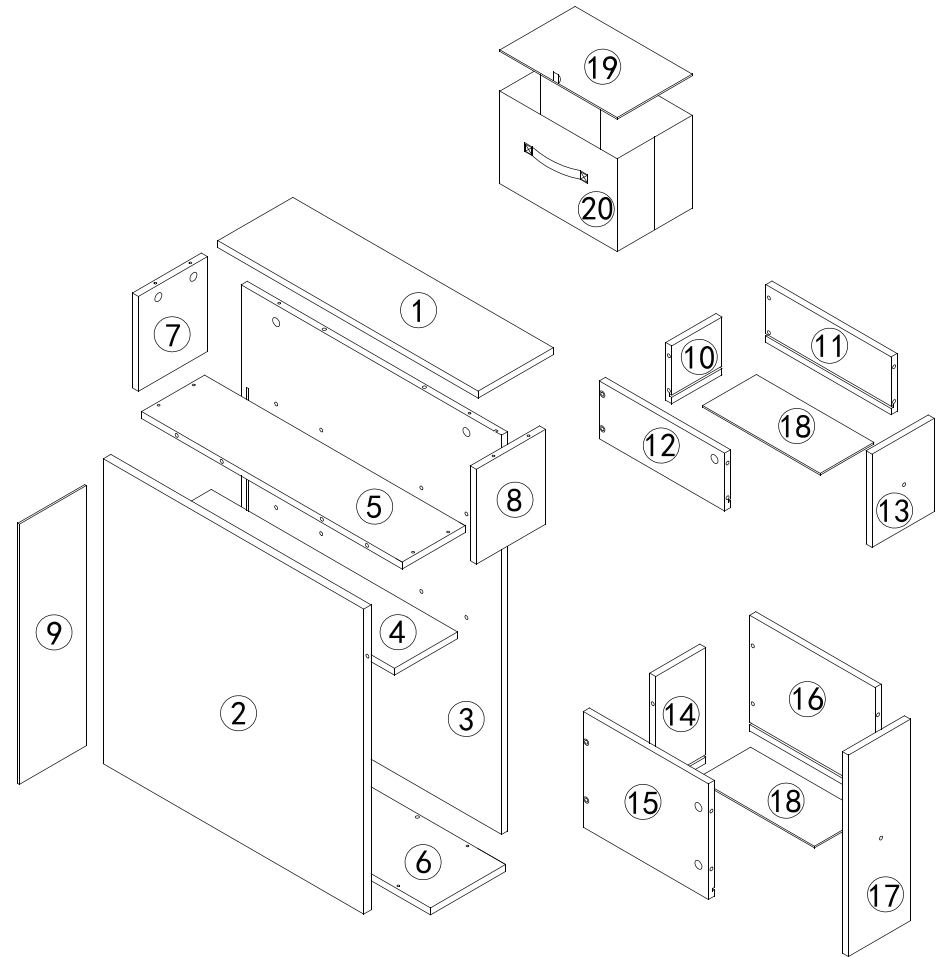

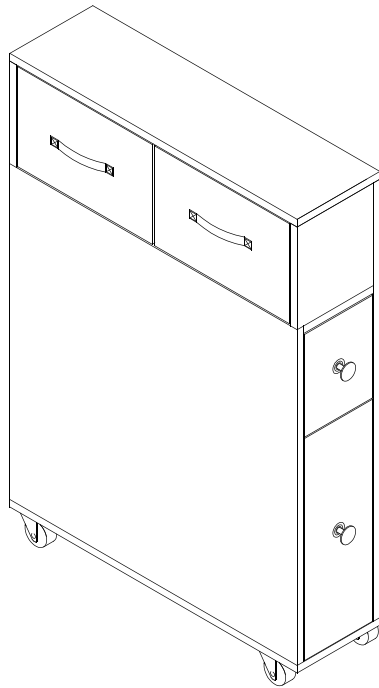

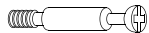





MODEL: FURNI-G-BATH-WH



<p><b>A</b></p>  <p>x20pcs</p>	<p><b>B</b></p>  <p>x20pcs</p>	<p><b>C</b></p>  <p><b>M6*30mm</b> x16pcs</p>	<p><b>D</b></p>  <p><b>M4*35mm</b> x16pcs</p>	<p><b>E</b></p>  <p>x2pcs</p>	<p><b>F</b></p>  <p>x2pcs</p>	<p><b>G</b></p>  <p>x16pcs</p>	<p><b>H</b></p>  <p>x2pcs</p>	<p><b>I</b></p>  <p>x2pcs</p>
---	---	--	--	--	--	---	--	--

# Assembly checklist



Read through the instructions carefully before you begin.



Make sure you have all the required tools. Do not use power tools.



Identify and lay out all of the components before you begin assembly.

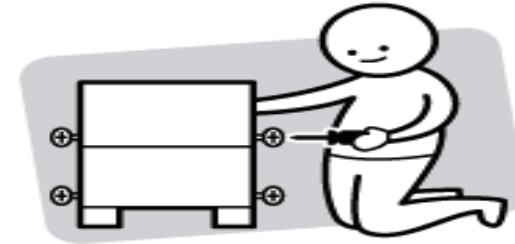

Do not fully tighten all screws until step/ process finished.

## Useful Information

! Never use power tools, they can damage your components or hardware if used incorrectly.

! The most common mistakes made during assembly are using the wrong hardware or getting components back to front.

! Always use a soft surface (such as carpet or cardboard) when assembling your product to avoid scratching or damaging the surface of the product.

### Step 1

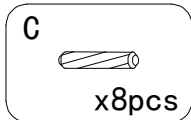
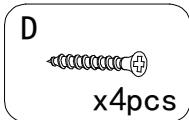
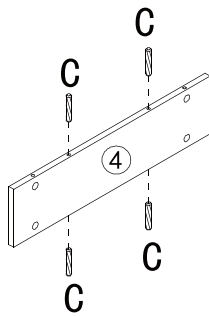
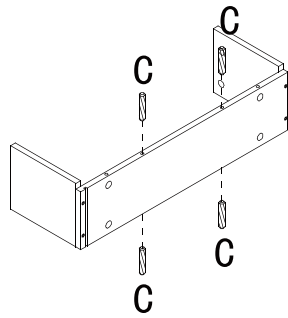
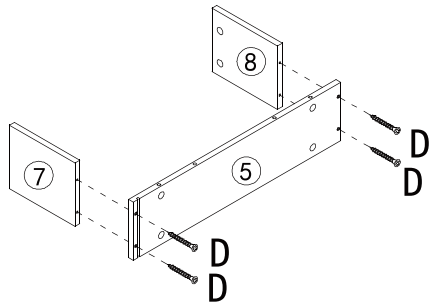

### Step 2

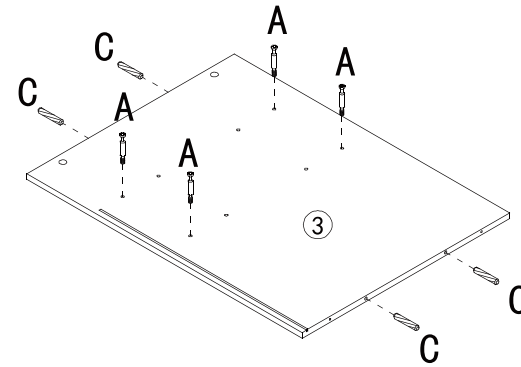
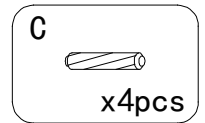
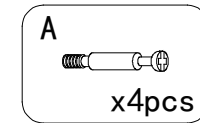

### Step 3

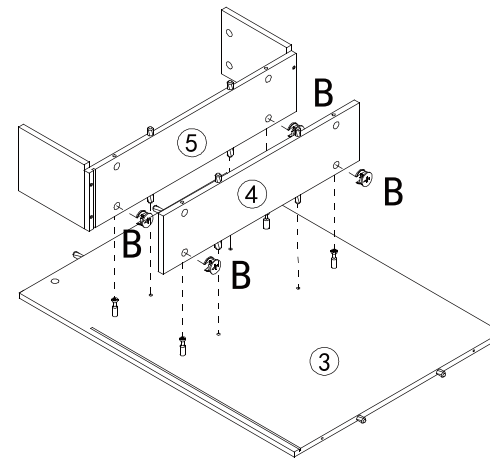
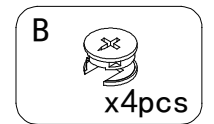

### Step 4

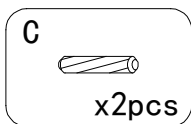
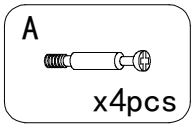
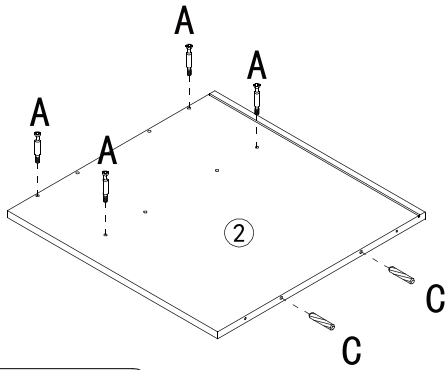

### Step 5

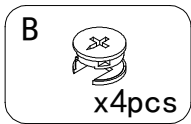
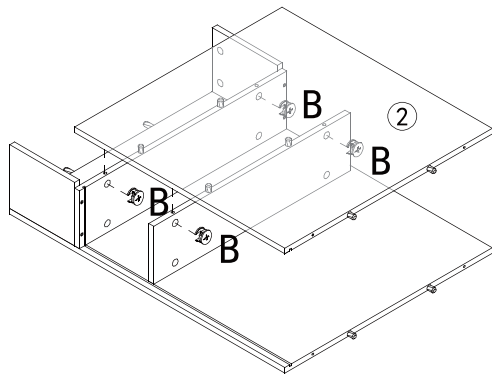

### Step 6

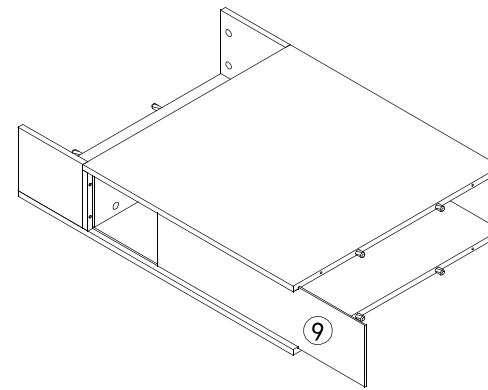

### Step 7

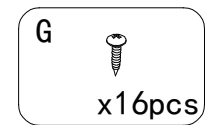
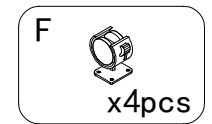
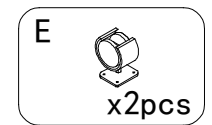
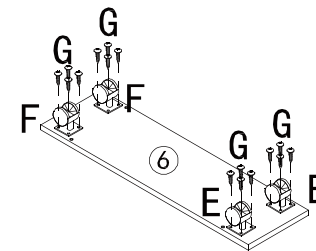

### Step 8

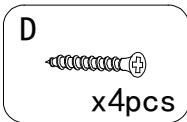
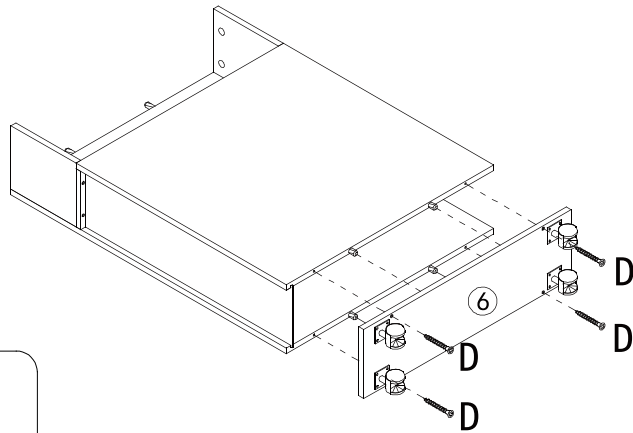

### Step 9

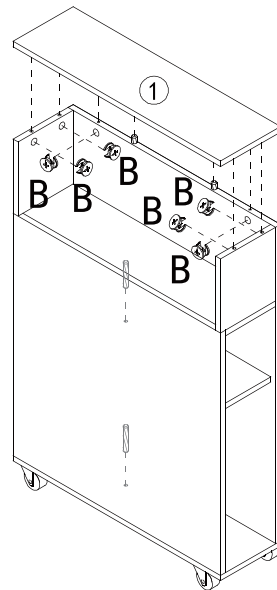
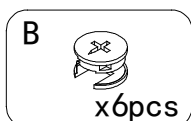
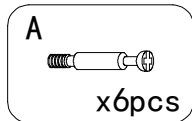
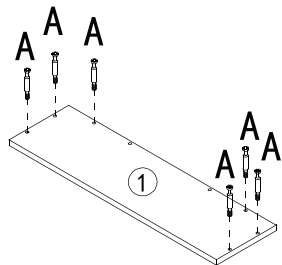

### Step 10

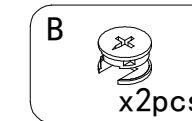
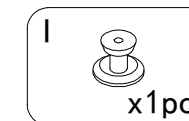
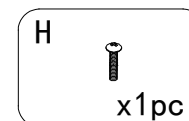
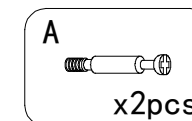
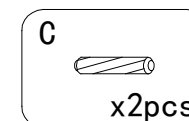
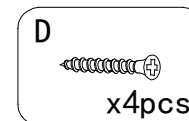
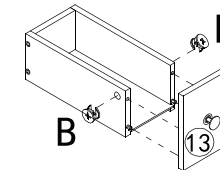
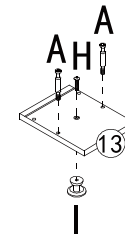
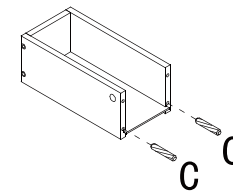
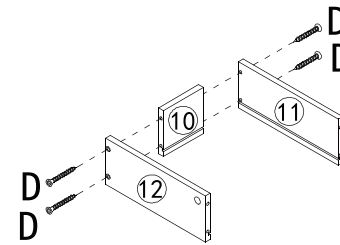

# Step 11

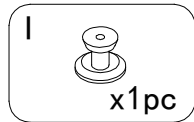
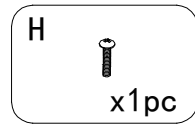
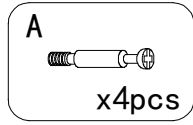
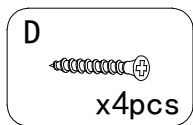
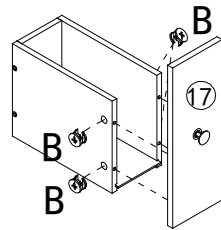
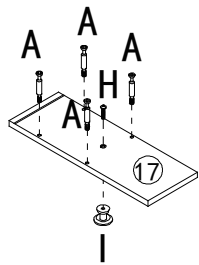
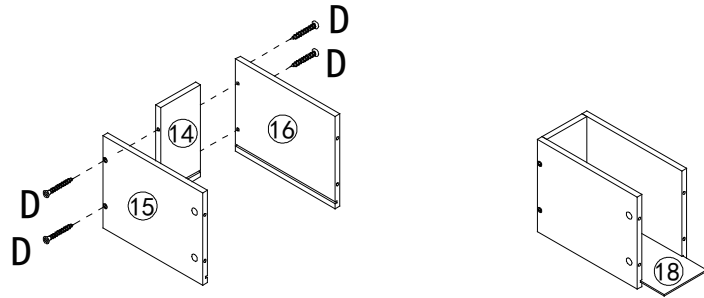

# Step 12

