

ASSEMBLY DIAGRAM

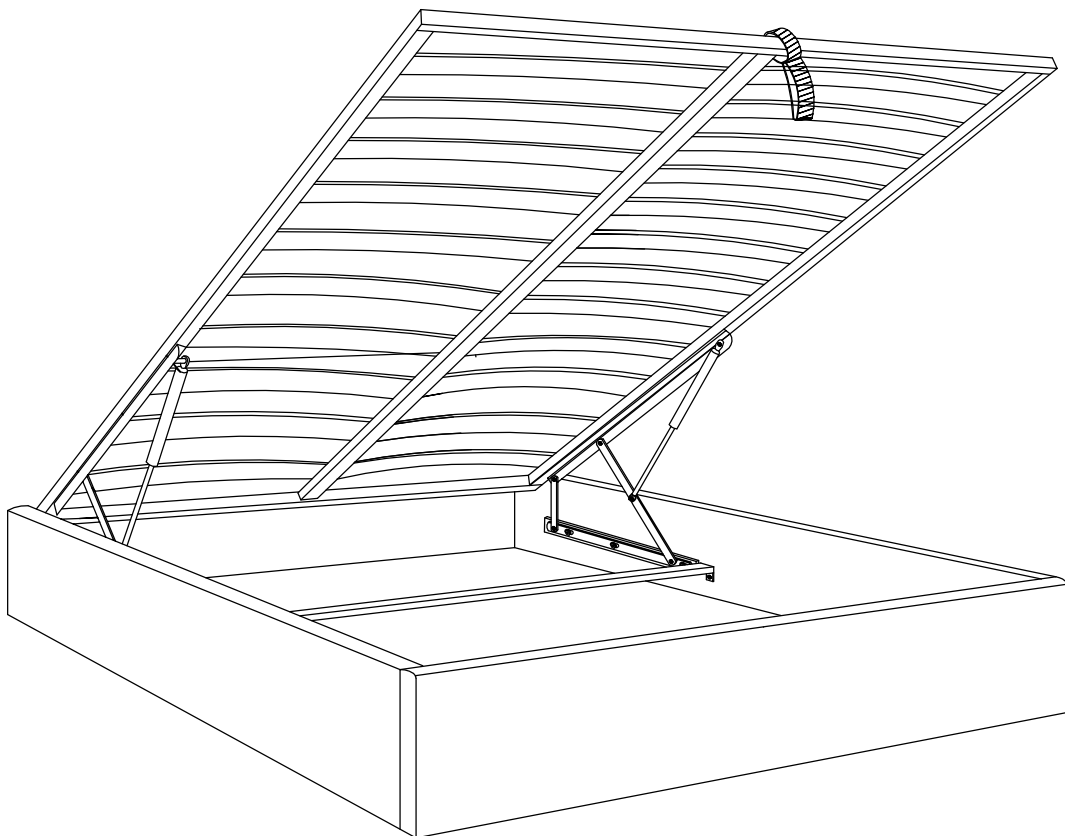



TOKI GAS LIFT BED FRAME

IMPORTANT NOTE:



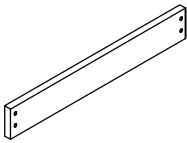
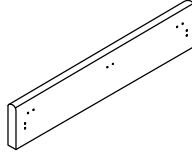
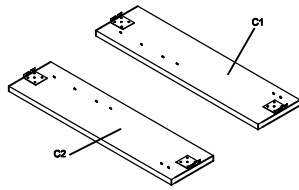
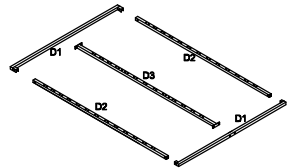
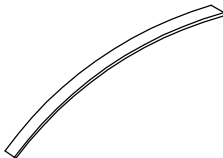
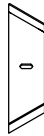
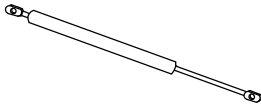
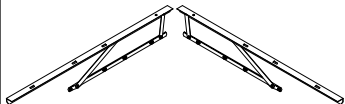

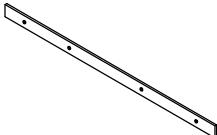

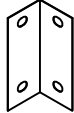
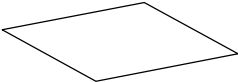



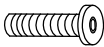

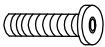





- ※PLACE ALL PARTS ON A CLEAN AND SMOOTH SURFACE SUCH AS A RUG OR CARPET TO AVOID THE PARTS FROM BEING SCRATCHED.
- ※KINDLY FOLLOW THE ASSEMBLY INSTRUCTIONS STEP BY STEP.
- ※DO NOT TIGHTEN ALL SCREWS UNTIL THE BED IS FULLY SET-UP.

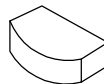

Parts List

A:HEAD BOARD 1PC 	B:FOOT BOARD 1PC 	C:SIDE RAIL 2PCS 	D:BEDSTEAD KD 1SETS 
E:SLAT 26PCS 	F:ANGLE IRON 2PCS 	G:STEAM MOVING BAR 2PCS (ASSEMBLED WITH H ALREADY) 	H:STEAM MOVING MECHANICA 2PCS 
I:SQUARE TUBE 1PC 	THIN WOODEN PLATE 2PCS J : 2PCS 	K : 1PC 	L : CONNECTOR 2PCS 
M : Non-Woven Bed Base 1PC 			

Hardware List

1:BOLT 14PCS  M8X45mm	2:BOLT 4PCS  M8X30mm	3:BOLT 8PCS  M6X40mm	4:BOLT 12PCS  M6X20mm	5:ALLEN KEY 1PC 	6:NUT 14PCS  M8
7:FLAT WASHER 28PCS  M8	8:SPRING WASHER 28PCS  M8	9:ALLEN KEY 1PC  M8	10:SPANNER 1PC 	11:SLAT CAP 26PCS 	12:DOUBLE PLASTIC CAP 13PCS 
13:ANGLE IRON 2PCS 	14:ALLEN KEY 1PC  M6	15:FLAT WASHER 20PCS  M6	16:SPRING WASHER 20PCS  M6	17 1PC 	18:BOLT 2PCS  M8X55mm
19:BOLT 8PCS  M8X25mm					

STEP 1

2  4PCS

19  8PCS

7  12PCS

8  12PCS

9  1PC

L  2PCS

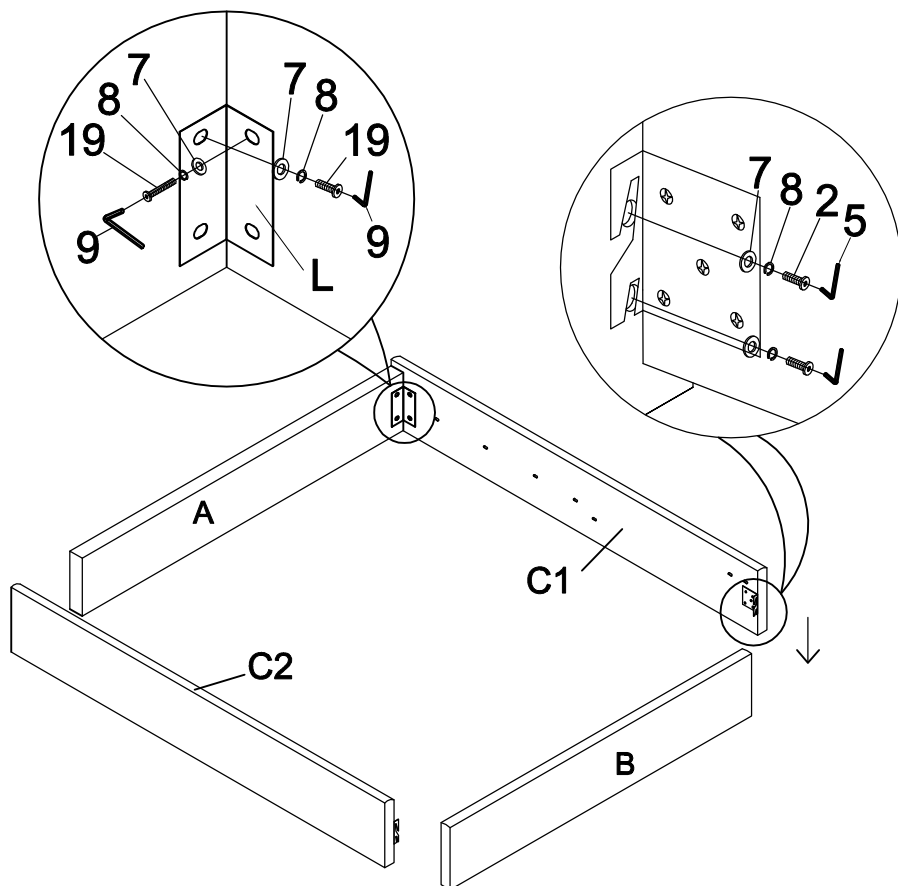
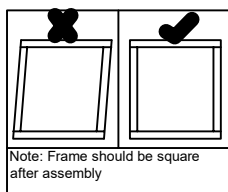

STEP 2

3  8PCS

15  8PCS

16  8PCS

14  1PC

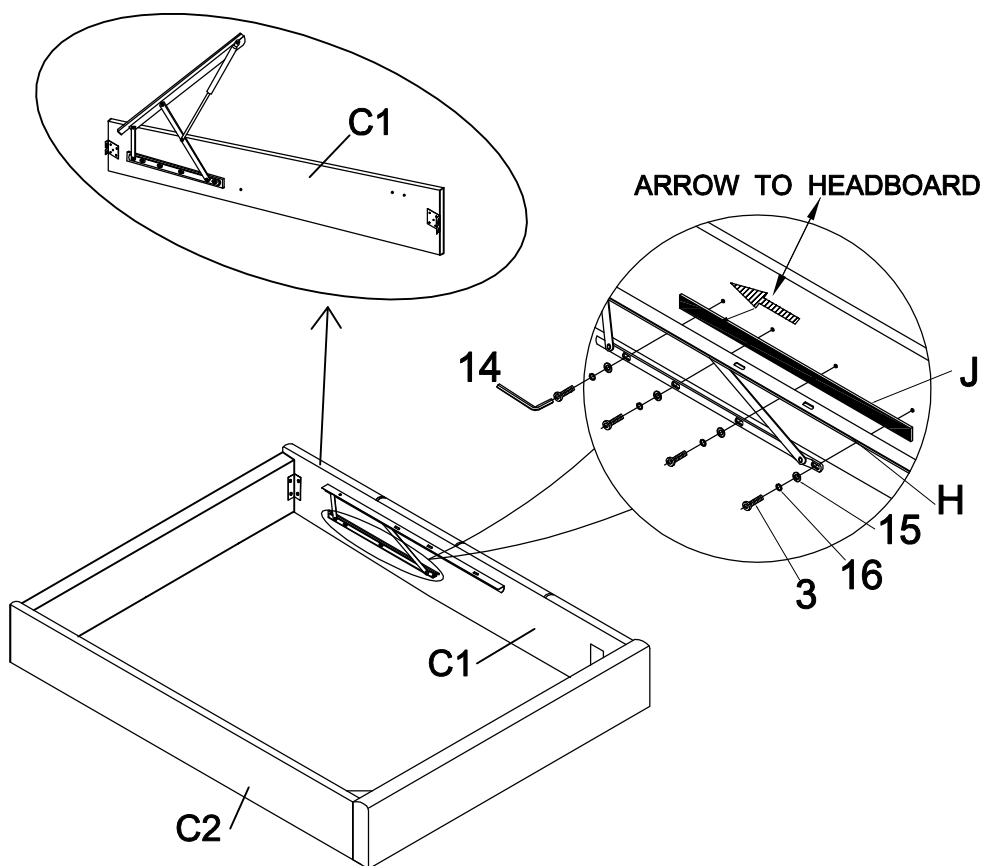

After C1's assembly, it's applicable for C2

STEP 3

4  4PCS

15  4PCS

16  4PCS

14  1PC

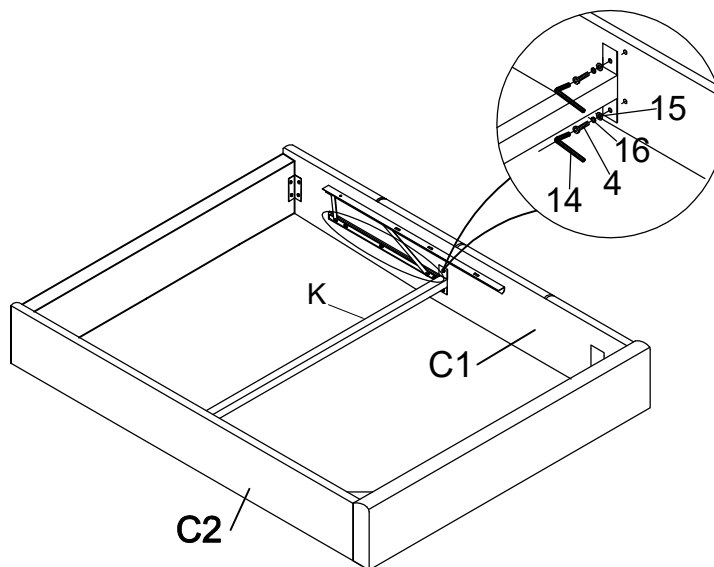

STEP 4

4  8PCS

15  8PCS

16  8PCS

18  2PCS

7  2PCS

8  2PCS

I  1PC

F  2PCS

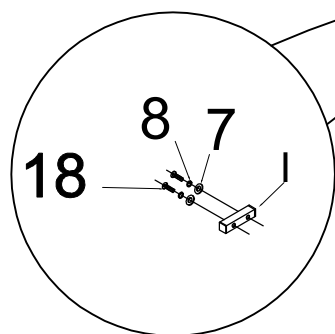
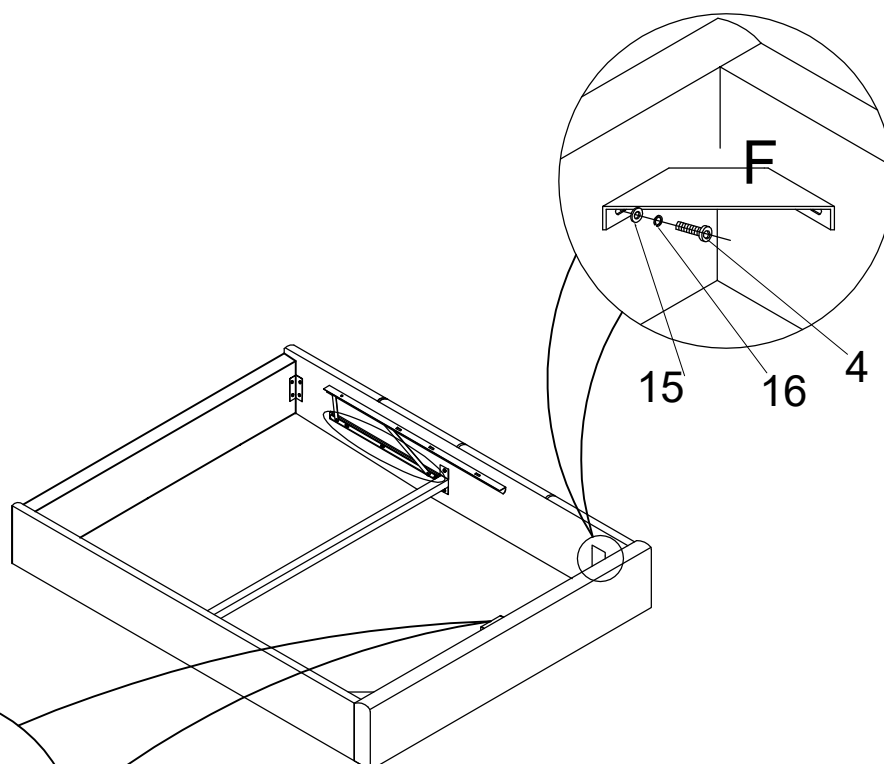



STEP 5

1  10PCS

7  10PCS

8  10PCS

6  10PCS

9  1PC

10  1PC

13  2PCS

17  1PCS

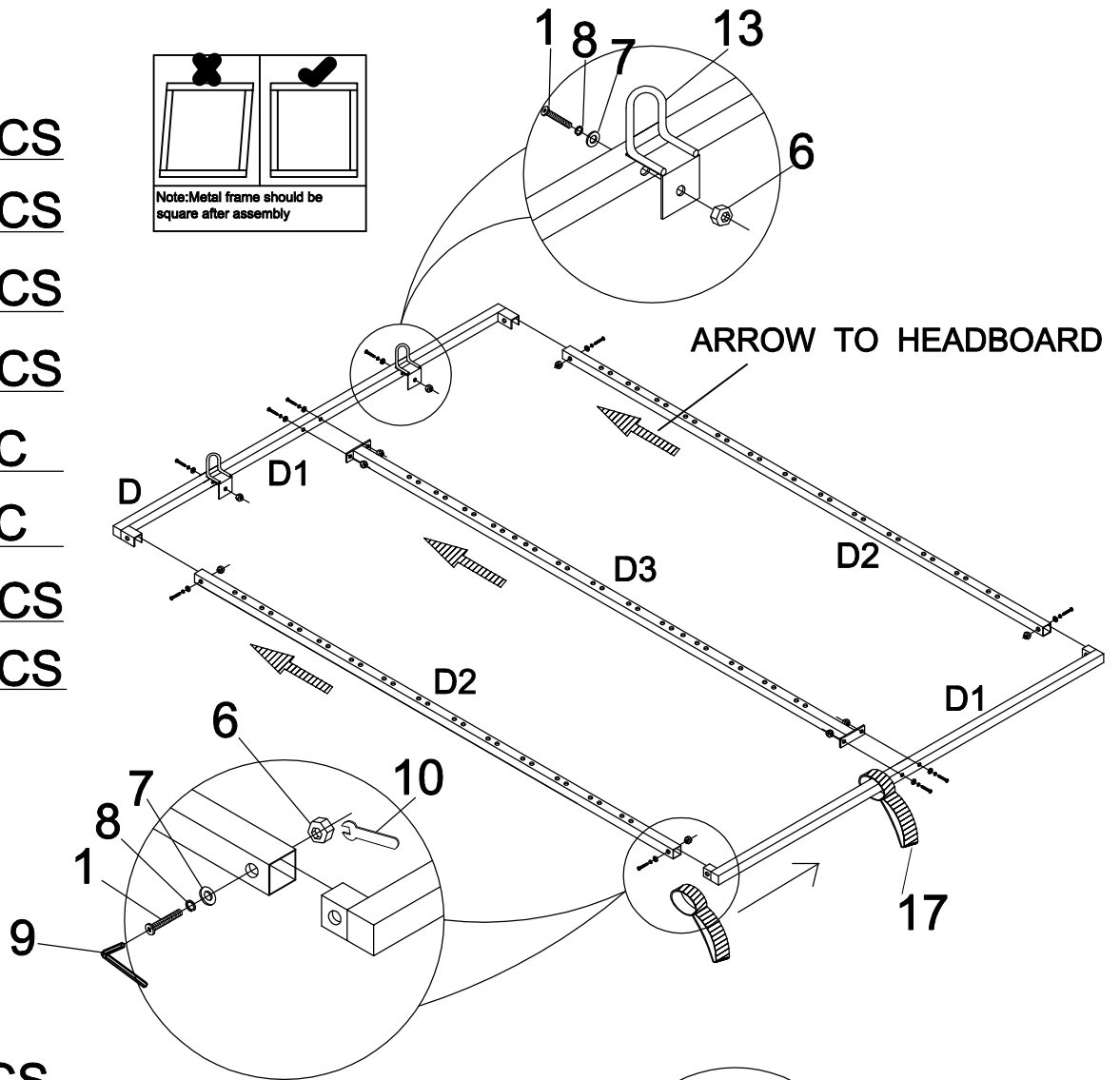

STEP 6

1  4PCS

7  4PCS

8  4PCS

6  4PCS

9  1PC

10  1PC

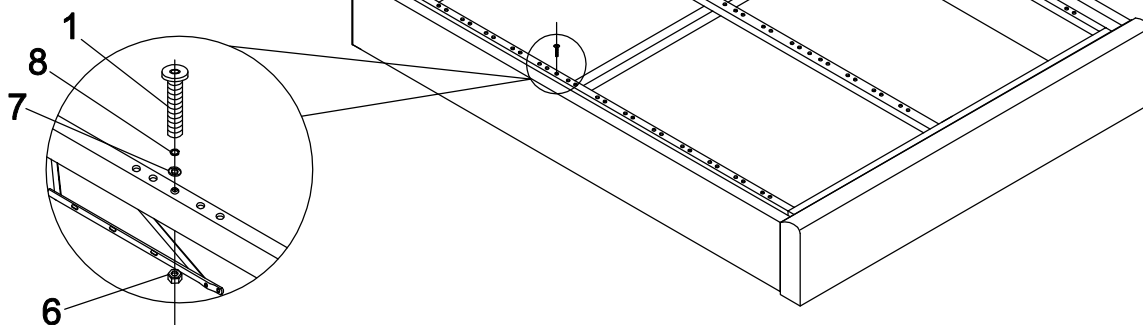

STEP 7

11  26PCS

12  13PCS

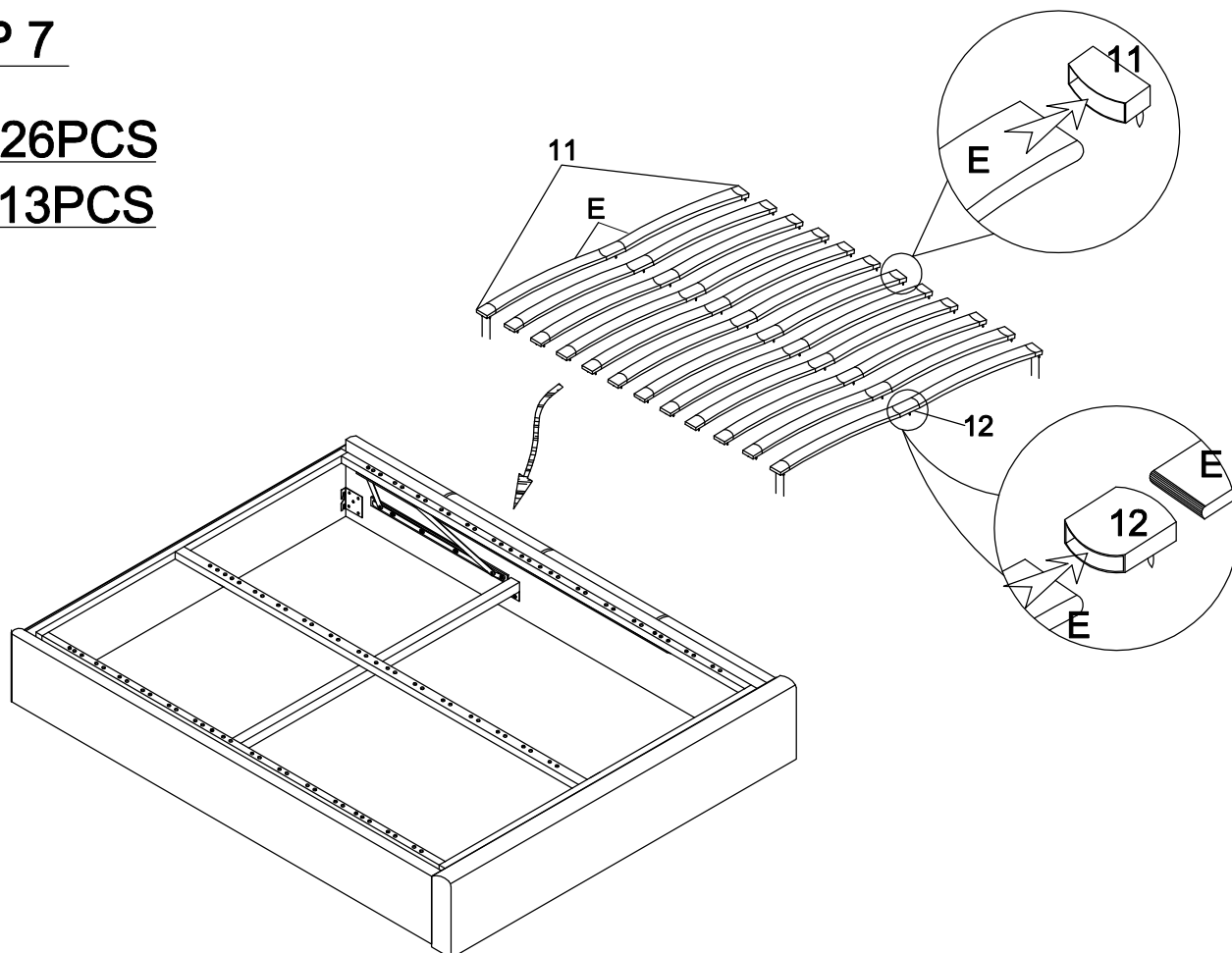

STEP 8

5  1PC

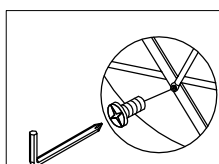
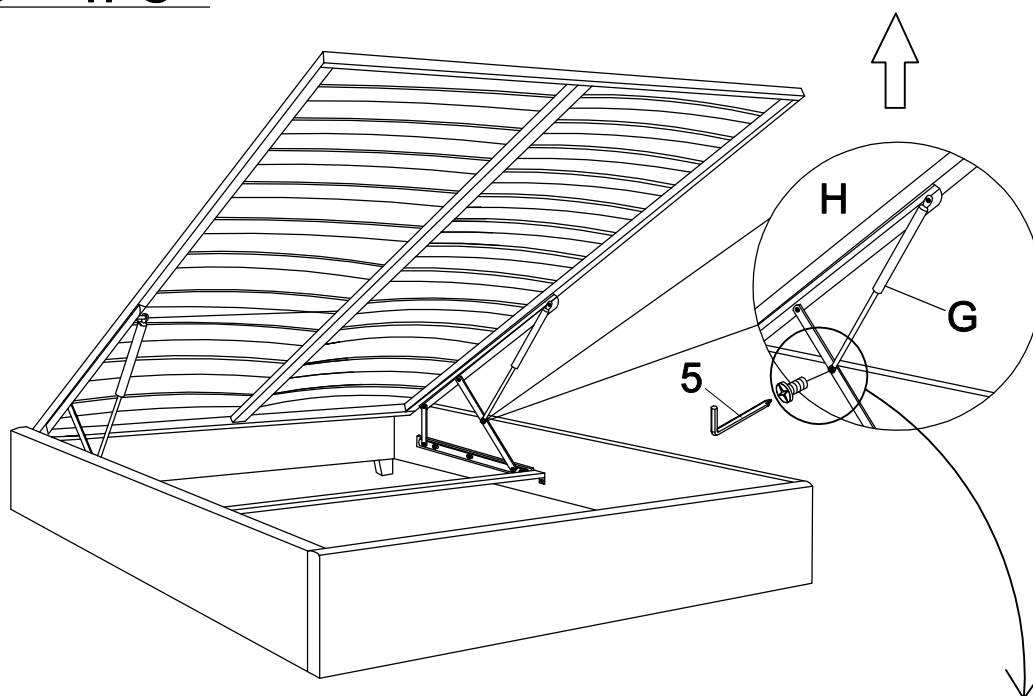

Lifting the base, remove the bolt shown (1pc) from Part H. ensuring that the base is supported and will not come down. Screw the bolt back in tightly

STEP 9

M  1PC

