

ASSEMBLY INSTRUCTIONS











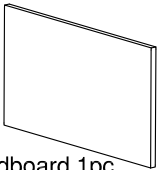
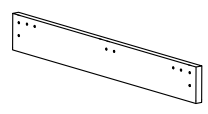
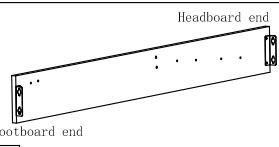
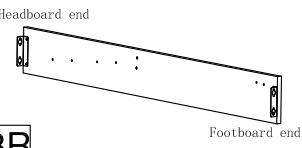
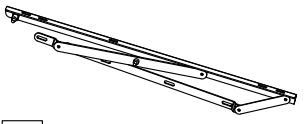
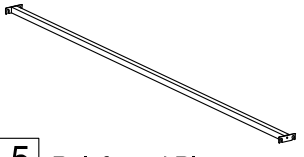
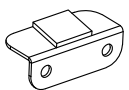
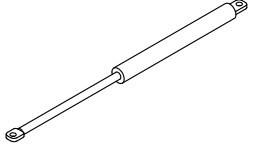
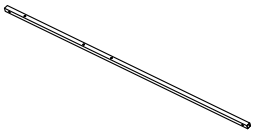

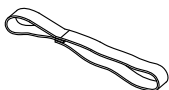
GAS-LIFT BED FRAME (DOUBLE/QUEEN SIZE)

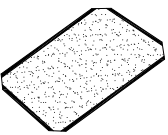
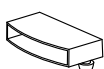
MODEL: BFRAME-G-LED-LUMI-D/Q

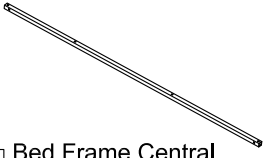

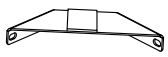

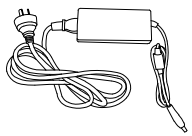





Top tips before assembly

1. Check that all parts are present before starting the assembly.
2. For ease and speed of assembly, it is recommended that all parts and hardware required for that step are identified before commencing assembly.
3. Place the product on a soft and padded surface to do the assembly to prevent damage to the finishes and surfaces of the product.
4. During assembly, do not over-tighten any fitting as this may damage the product.



Parts List

| | | | |
|--|---|---|--|
|  <p>1 Headboard 1pc</p> |  <p>2 Footboard 1pc</p> |  <p>3L Side Rail Left 1PC</p> |  <p>3R Side Rail Right 1PC</p> |
|  <p>4 Hinge 2pcs</p> |  <p>5 Reinforced Pipe 1pc</p> |  <p>6 Angle Iron 2pcs</p> |  <p>7 Gas Strut 2pcs</p> |
|  <p>8 Bedstead Side Pipe 2pcs</p> |  <p>9 Front And Rear Frameworks 2pcs</p> |  <p>10 Rope 1pc</p> |  <p>11 Slats Double 24pcs Queen 26pcs</p> |
|  <p>12 Bottom cloth 1PC</p> |  <p>13 Plastic Slat Caps Double 24pcs Queen 26pcs</p> |  <p>14 Centre Slat Caps Double 12pcs Queen 13pcs</p> |  <p>15 Bed Frame Central Pipe 1pc</p> |
|  <p>16 Leg 4pcs</p> |  <p>19 Metal Corner Bracket 2pcs</p> |  <p>22 Centre Support Leg 2pcs</p> |  <p>23 Remote Control 1PC</p> <p>Unplug the battery separator of the remote control before use</p> |
|  <p>24 LED Power Transformer 1PC</p> |  <p>25 Controller 1PC</p> | | |

Hardware List

| | | | | |
|--|---|--|--|---|
|  A M8x40mm Bolt 12pcs |  B M8x30mm Bolt 8pcs |  C M8x16mm Bolt 12pcs |  D Plastic washer 8PCS |  E M6x35mm Bolt 2pcs |
|  F M8 Nut 16pcs |  G Spanner 1PC |  H Allen Key 1PC |  L Flat Washer 14PCS |  P 4.0x40mm Screw 4PCS |

NOTE
The M8 bolts J are pre-installed in the headboard and footboard and bolts K are pre-installed in the side rails. Loosen them by turning them anti-clockwise until they are about 12mm out to begin assembly with other parts of the bed frame.

| | |
|---|---|
|  J M8x25mm Bolt 8PCS |  K M8x18mm Bolt 4PCS |
|---|---|

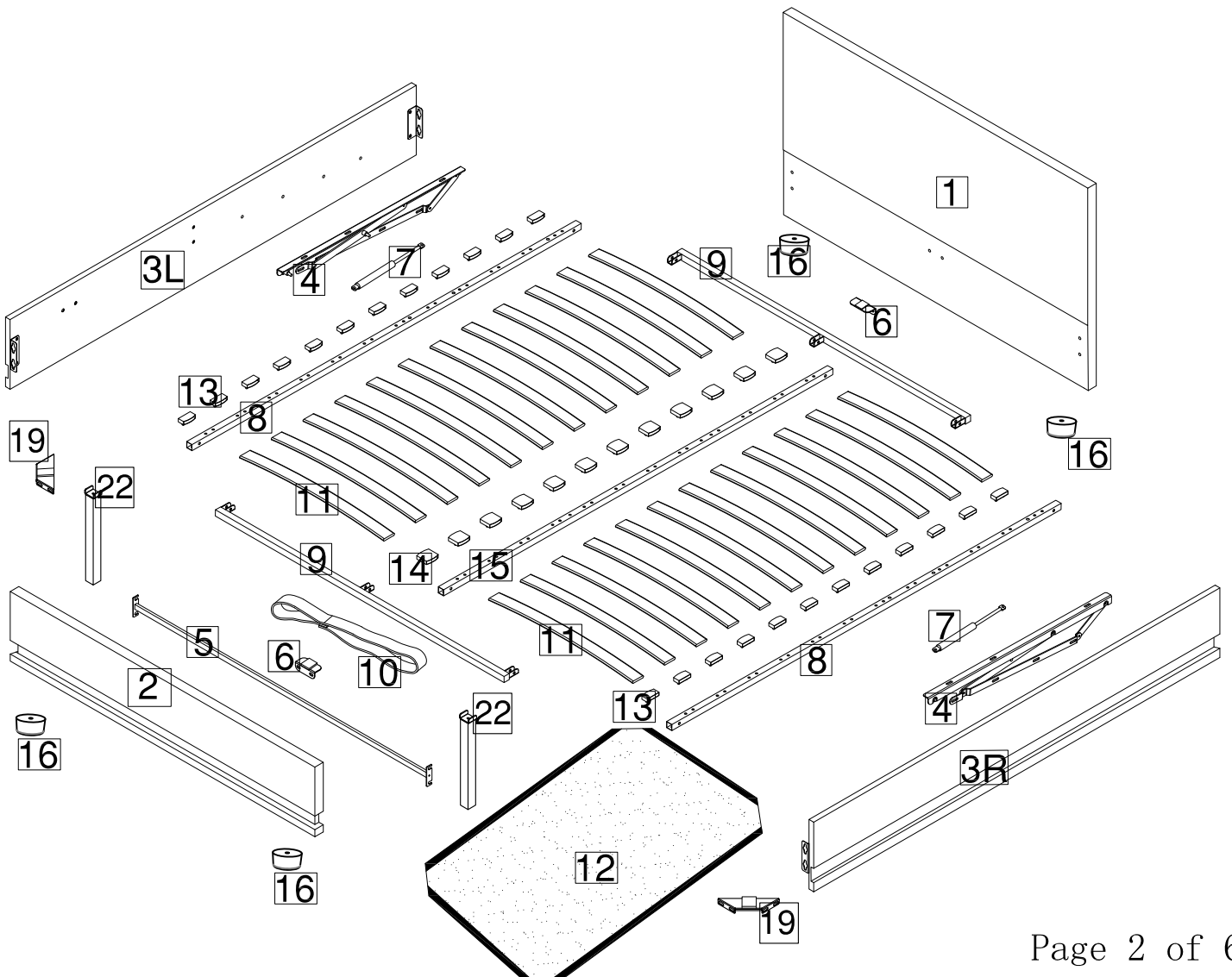

Step 1:

- Ⓟ 4PCS
- Ⓒ 4PCS
- Ⓜ 1PC

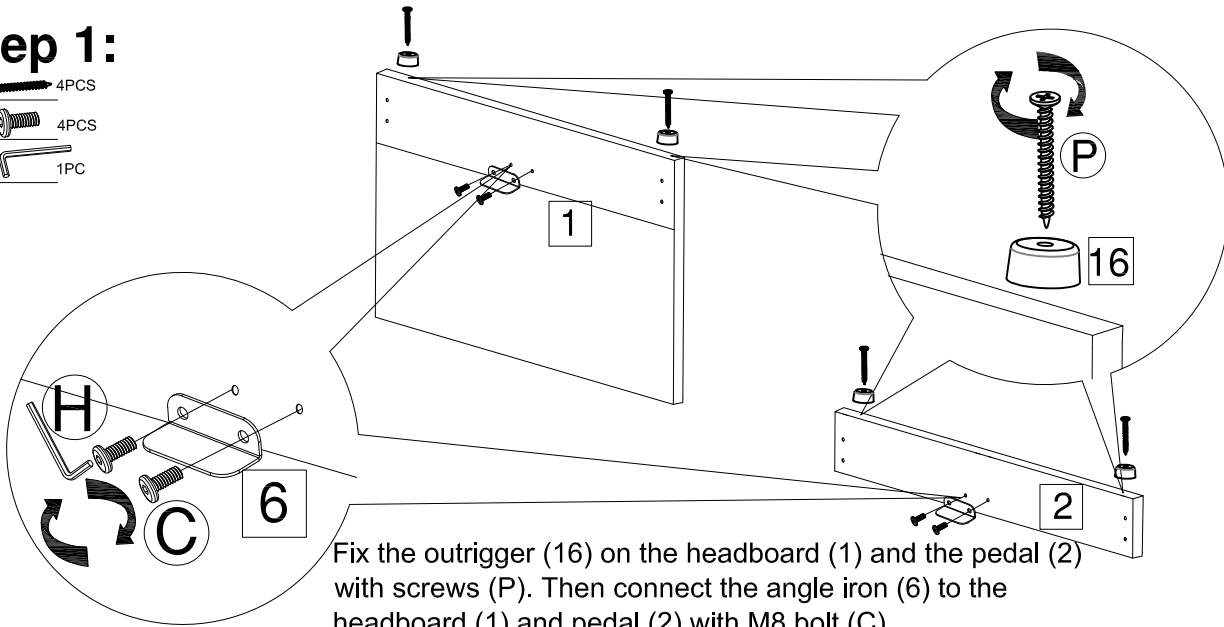

Fix the outrigger (16) on the headboard (1) and the pedal (2) with screws (P). Then connect the angle iron (6) to the headboard (1) and pedal (2) with M8 bolt (C).

Step 2:

- Ⓚ 4PCS
- Ⓟ 8PCS
- Ⓛ 8PCS
- Ⓜ 1PC

Loosen the M8 bolts (K) by turning them anti-clockwise until they are about 12mm out.

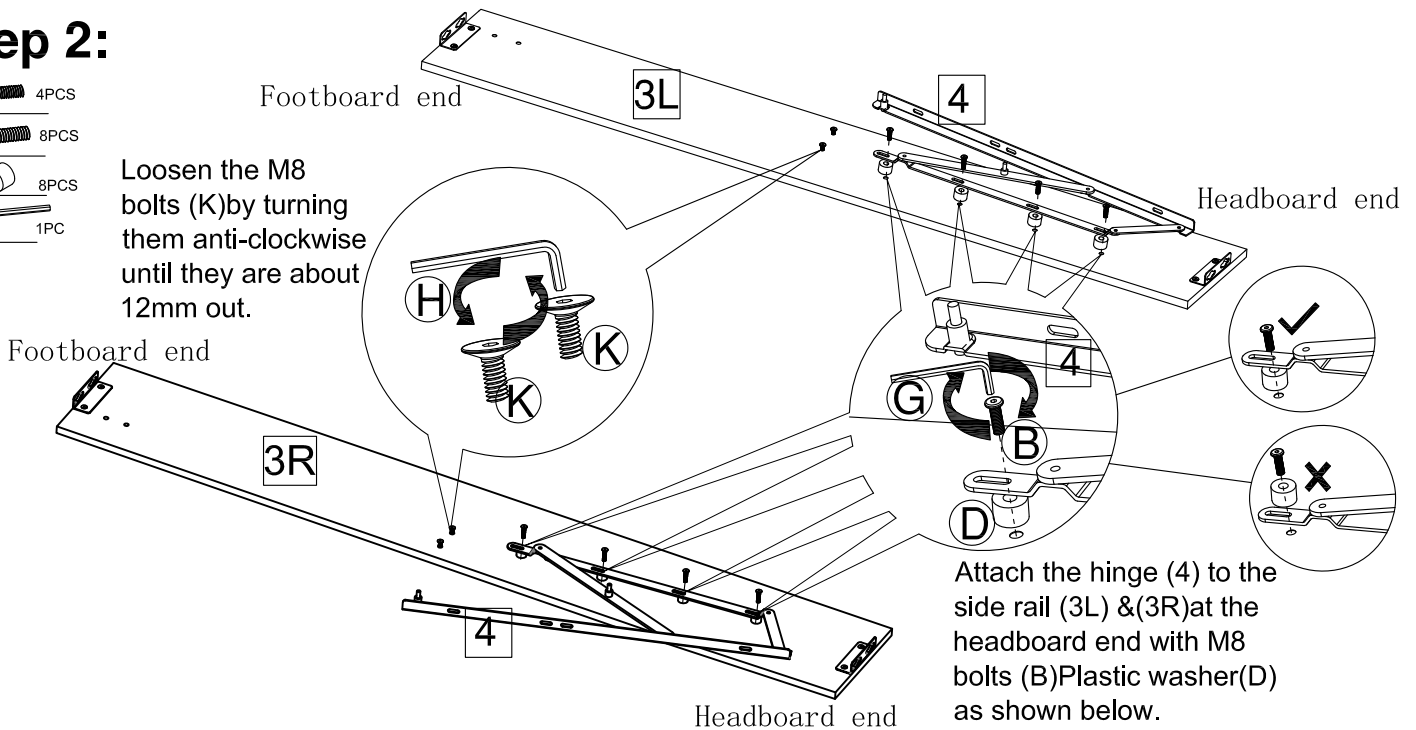

Attach the hinge (4) to the side rail (3L) & (3R) at the headboard end with M8 bolts (B) Plastic washer (D) as shown below.

Step 3:

Loosen the M8 bolts (J) by turning them anti-clockwise until they are about 12mm out before attaching the side rail assembly (3L) to the headboard (1) and footboard (2).

- Ⓜ 8PCS
- Ⓜ 1PC

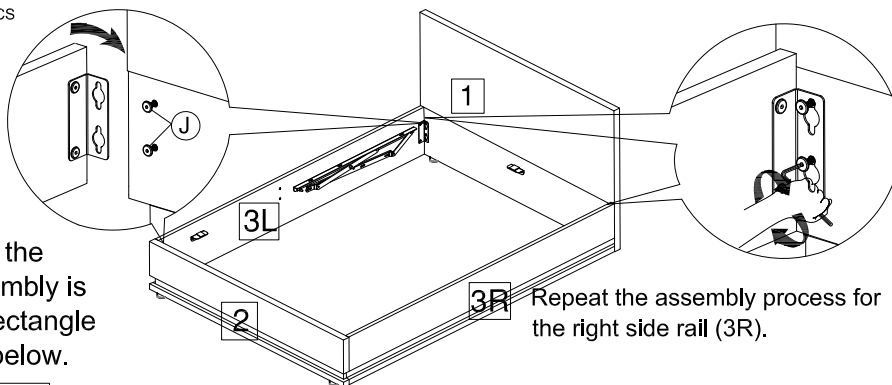
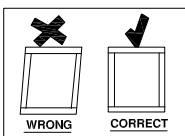

Ensure the the entire assembly is a regular rectangle as shown below.

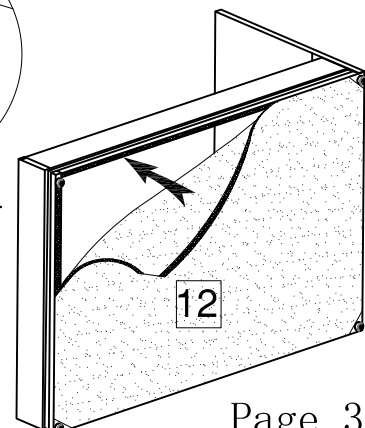

Turn the bed over and stick the bottom cloth (12) around the bottom of the bed.



Step 4:



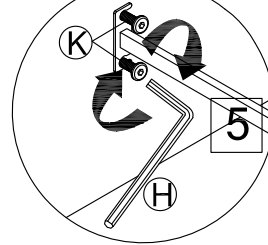
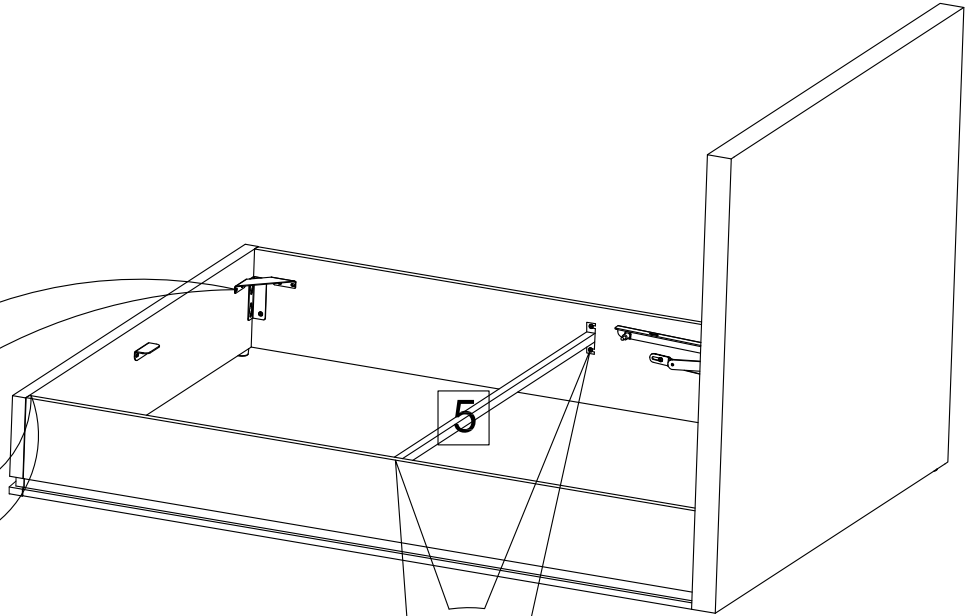
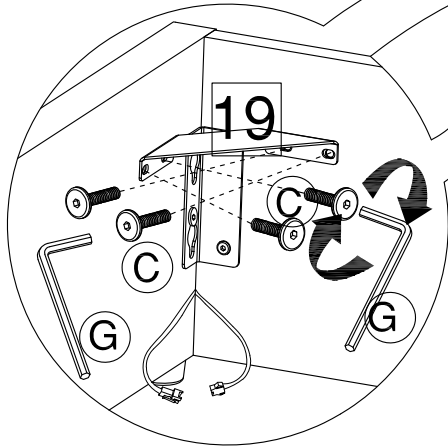

-  4PCS
-  8PCS
-  1PC

Connect metal corner bracket (19) to side rail and footboard with M8 bolts (C).



Attach the reinforced cross pipe (5) to the bed frame with M8 bolts (K).

Step 5:

-  6PCS
-  6PCS
-  12PCS
-  1PC
-  1PC

Ensure that the holes are aligned when joining 8 and 9.



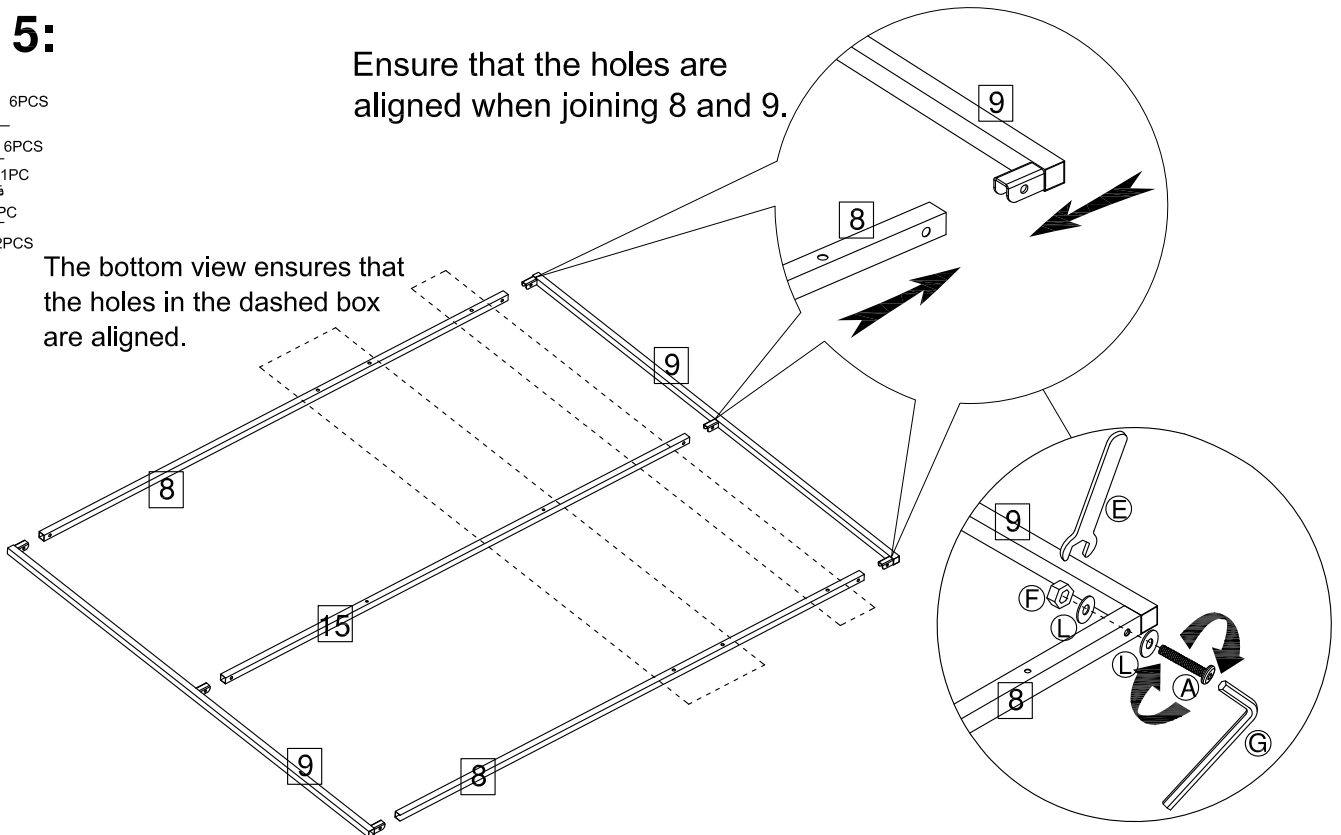



The bottom view ensures that the holes in the dashed box are aligned.



Assemble the interior framework (8, 15 and 9) as shown with M8 bolts (A) Flat Washer(L) Non-slip nuts(F).

Step 6:

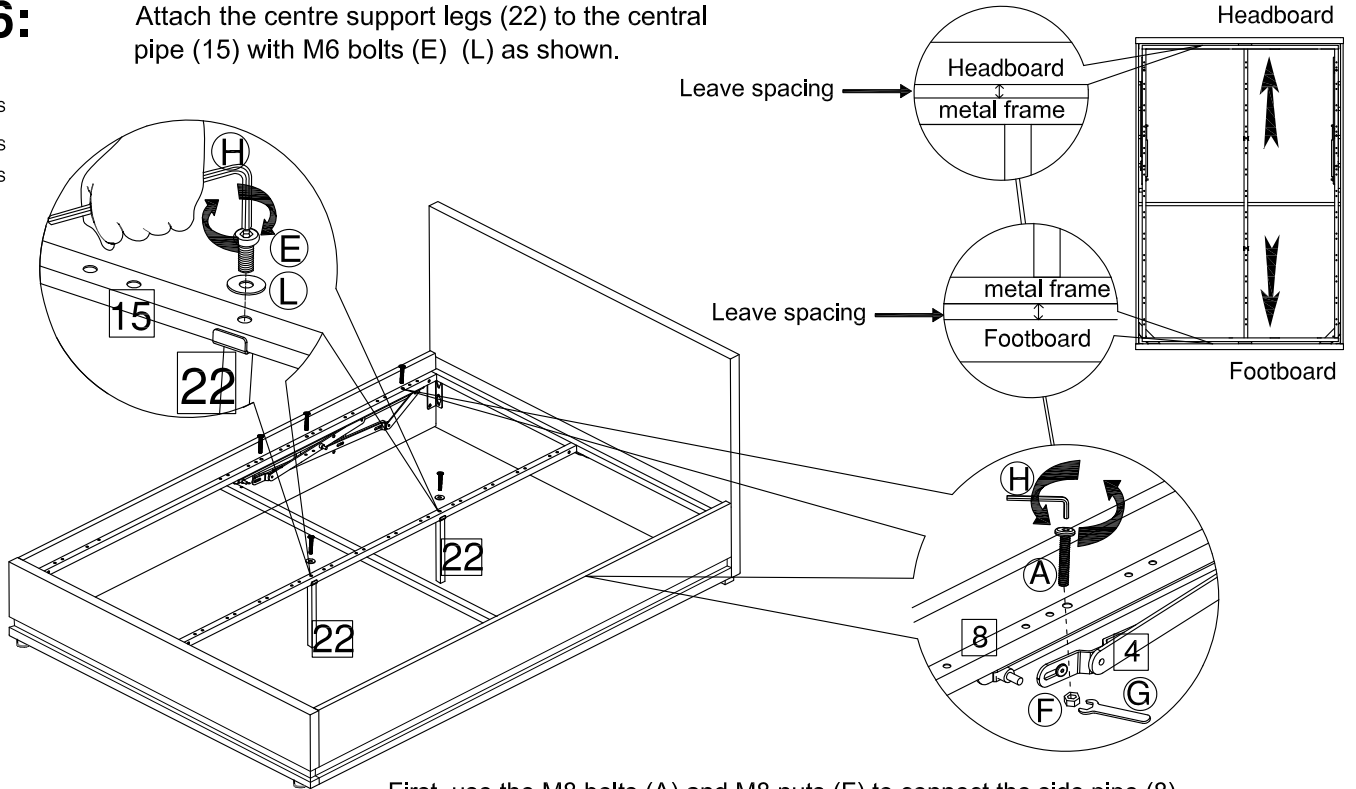

Attach the centre support legs (22) to the central pipe (15) with M6 bolts (E) (L) as shown.

-  6PCS
-  2PCS
-  6PCS
-  1PC
-  1PC
-  2PCS



First, use the M8 bolts (A) and M8 nuts (F) to connect the side pipe (8) to the hinge (4). At this stage, do not fully tighten the M8 bolts (A) to allow for some adjustment between the headboard, footboard and metal frames. There should be some spacing between the headboard, footboard and the metal frames. Once every part is aligned, fully tighten all M8 bolts (A).

Step 7:

-  4PCS
-  1PC
-  1PC

Attach the gas struts (7) to the hinge (4) with M8 nuts (F) as shown.

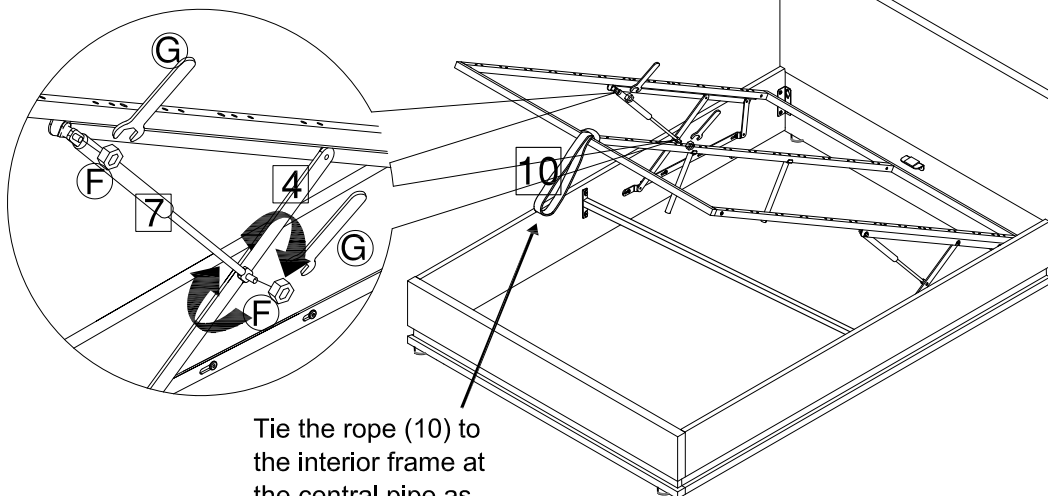

Tie the rope (10) to the interior frame at the central pipe as shown.

LIFTING THE BED FRAME

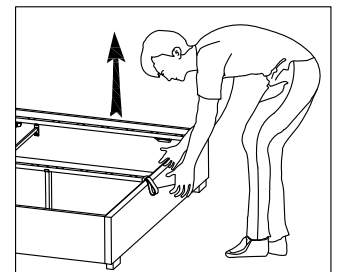

Pull the rope with both hands to lift the bed frame.

LOWERING THE BED FRAME

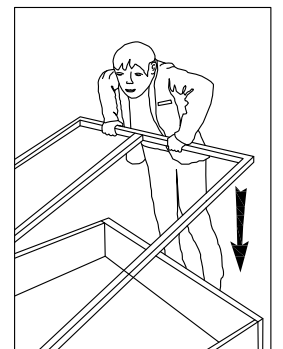

To lower the bed frame, press it down with both hands as shown.

Step 8:

13 Double 24pcs
Queen 26pcs

14 Double 12pcs
Queen 13pcs

Attach the plastic slat caps (13) to each slat (11) at the side. Then press down the caps into the corresponding holes on the side pipes (8) as shown.

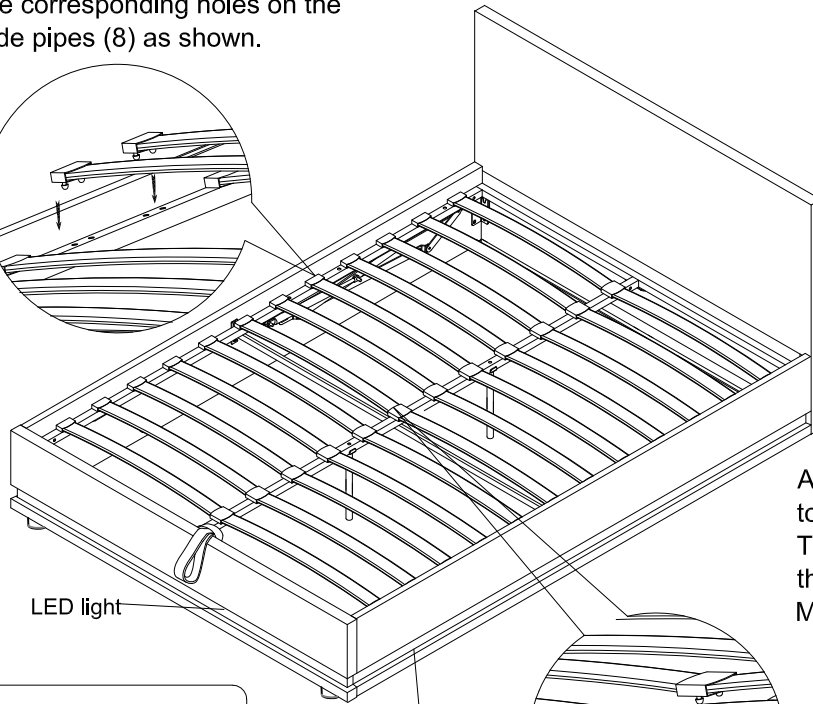
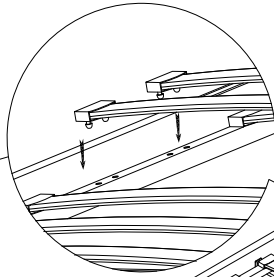
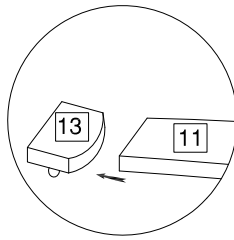

Attach the plastic slat caps (14) to each slat (11) at the side. Then press down the caps into the corresponding holes on Middle tube (15) as shown.

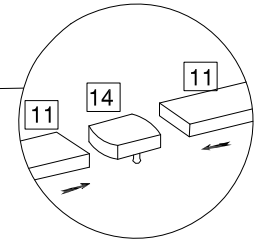
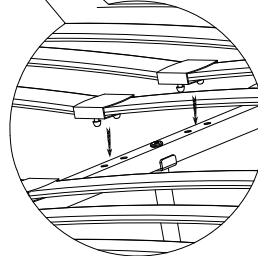
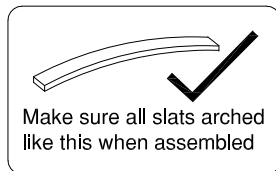

Step 9:

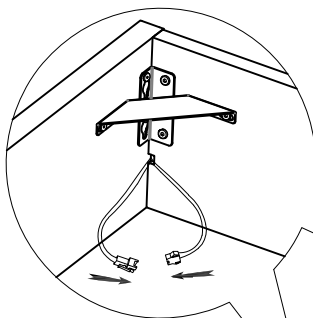

The LED light wires on both sides of the inside of footboard (2) are connected with the light wires of side rail left (3L) side rail right (3R)

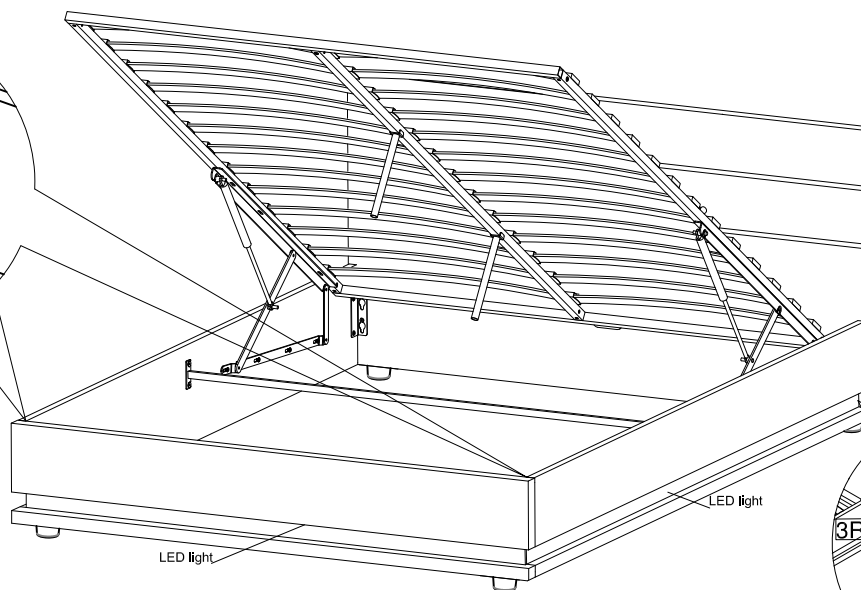

Connect the LED controller (19) to the Side Rail Right (3R). Then plug in the power adaptor (18) to the controller as shown.

